

Single Cell Range

Ni-Cd batteries

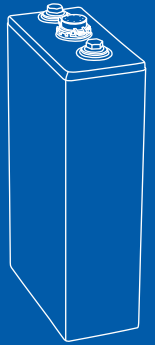

Reliability inside

ALCAD

Alcad Single Cell Range

the reliability you need at the heart of your power backup system



Versatility for industry

Alcad Single Cell nickel-cadmium (Ni-Cd) batteries offer the versatility to industry where reliable performance is crucial, even under extreme operating conditions, for example in :

- substations
- power plants
- onshore and offshore oil & gas applications
- refineries
- airports
- building infrastructure

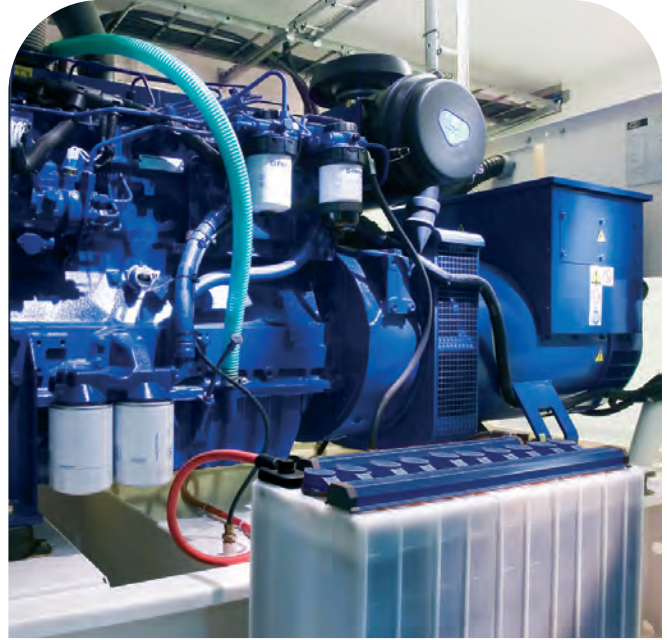

Reliability for backup power application

If primary power sources fail, Alcad batteries enable your backup system to provide vital systems support to keep operations moving until primary power is restored or a controlled shutdown can be performed, including for :

- UPS (Uninterruptible Power Supply)
- substation switchgear
- switching and transmission
- emergency and security
- industrial fire monitors and alarms
- process control
- signaling

Security for starting applications

For generator starting or switching on heaters, pumps and other essential equipment in an emergency, Alcad batteries meet the specific need for high discharge, instant voltage recovery and reliable operation, even in extreme temperatures.

“
 Alcad has a Single Cell range to suit every discharge profile from 1s to 100 h
 ”

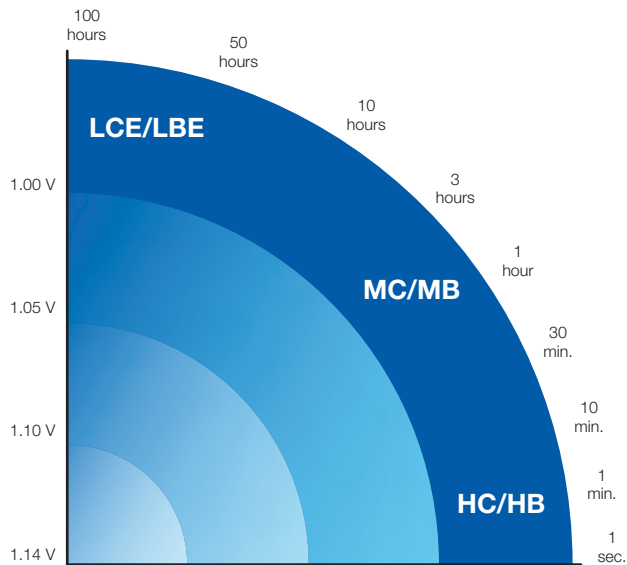

A broad range of capacity and performance

Alcad Single Cells are available in low rate discharge, medium and high performance types LCE/LBE, MC/MB, HC/HB and offer:

- simple maintenance
- 20+ years design life
- wide temperature range operation
- resistance to electrical abuse, shock and vibration
- low life cycle cost

	LCE/LBE	MC/MB	HC/HB
Capacity steps	58	68	47
Capacity	10 - 1690 Ah	9 - 1440 Ah	9 - 920 Ah
Performance	For low rate discharge over long periods between 1 and 100 hours	For varied loads with low and high discharge rates between 30 minutes and 3 hours	For high rate discharge over short periods less than 30 minutes
Applications	Power back-up applications	Power back-up applications	Power back-up and starting applications

“
 It is easy to specify the ideal battery for every stationary application, based upon required discharge time and end of discharge voltage.
 ”



Alcad Ni-Cd technology
robust and reliable by
design, proven in practice

“
Improved performance
and more capacities allow
you to select the best,
cost-effective battery for
your application.
”

**Alcad’s wide range enables
the best solution for your
application optimised
according to plate thickness**

- LCE/LBE range**
 - Thickest plates
 - High energy
 - Low cost per Ampere at low rates
- MC/MB range**
 - Thinner plates
 - Medium power
 - Optimised between H and L design for mixed loads
- HC/HB range**
 - Thinnest plates
 - High power
 - Low cost per Ampere at high rates

- Optimised design boosts electrical performance by up to 10% depending on discharge time.
- More capacities than previous designs enables the battery to be sized more closely to exact requirements.

Because it’s Ni-Cd, it’s reliable

Alcad’s robust Ni-Cd pocket plate technology is particularly well suited to the complex requirements of installations in difficult and demanding conditions, and in remote and inaccessible locations.

- Delivers performance, reliability and a long, totally predictable service life, with no risk of sudden death failure.
- Ensures a 20+ years’ service life at +25°C (+77°F).
- Even at +35°C (+95°F), service life is reduced by just 20% compared with a 50% reduction for a lead-acid battery.
- Operating temperature -20°C (-4°F) to +55°C (+131°F)

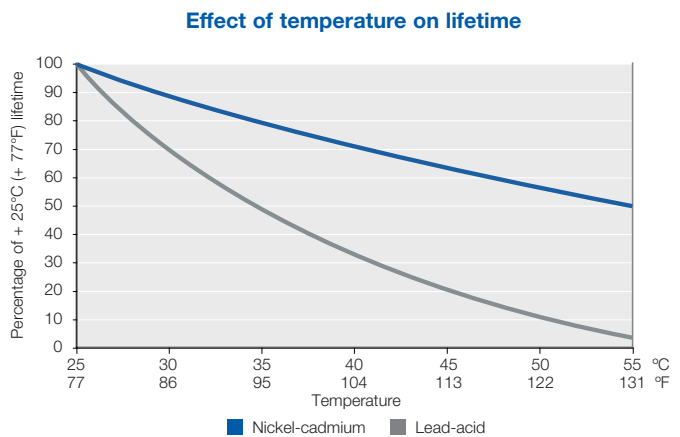

Single Cell construction

- Steel pocket plate structure does not suffer from 'sudden death' or internal corrosion since there is no interaction between the active material and the electrolyte.
- Tough polypropylene casing ensures structural integrity throughout a long life.
- Specially designed flame arresting flip top vent ensures safe operation
- Engineered electrolyte solution delivers optimum performance without causing degradation of plate materials.
- Plenty of space is allowed for a good reserve of electrolyte.
- Special electrolyte is available for extremely low temperature applications.
- Single Cell batteries offer a long shelf life when stored under Alcad's recommended conditions and are easy to install.

1 Protective cover

In line with IEC 62485-2 / EN 50272-2 (safety) with IP2 level

2 Flame-arresting vent

Compliant with UL 1989 Section 7 - Flame arrester vent cap tests

3 Plate group busbar

4 Plate tab

5 Plate frame

6 Separating grids

7 Cell container

8 Alcad pocket plate technology



Note: Alcad Single Cell ranges fully comply with the requirements of the IEC 60623 standard.



“

Demands in our industry change quickly. Through their strength and reliability, Alcad batteries enable us to deliver the high level service our customers expect.

”



Extending and improving battery design to meet evolving industrial needs

Lower maintenance contributes to lower Total Cost of Ownership (TCO)

- Topping-up interval extended by up to two times in standard conditions at + 20°C (+ 68°F) and at float voltage.
- A simple annual maintenance inspection is recommended to check correct functioning of the charging system, battery and the auxiliary electronics.
- Easy maintenance built-in by design:
 - Visible electrolyte level
 - Simple bolted connector for fast installation and allowing the battery to be quickly commissioned.

Typical topping up intervals at recommended charge voltage

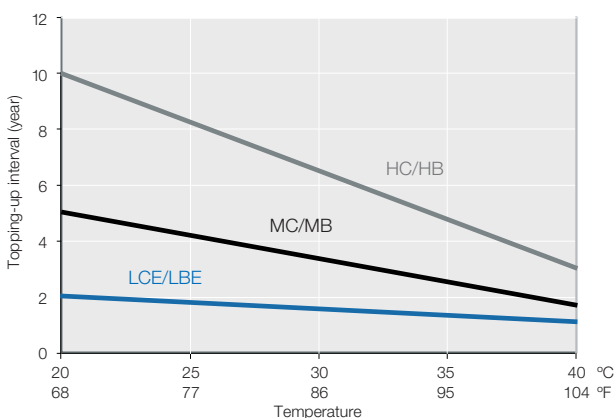

Higher chargeability to minimise downtime

- Faster recharge time enables at least 80% recovery of capacity from fully discharged conditions in 15 hours at float voltage level.

Recommended charging voltage:

• For two level charge:

- Float level:
 - 1.42 ± 0.01 V/cell for LCE/LBE
 - 1.40 ± 0.01 V/cell for MC/MB and HC/HB

- High level:
 - 1.47 - 1.70 V/cell for LCE/LBE
 - 1.45 - 1.70 V/cell for MC/MB and HC/HB

A high voltage will increase the speed and efficiency of the recharging.

• For single level charge:

- 1.43 - 1.50 V/cell.



LCE/LBE Range – Available capacity after constant voltage charge at 1.42 V at + 20°C (+ 68°F)

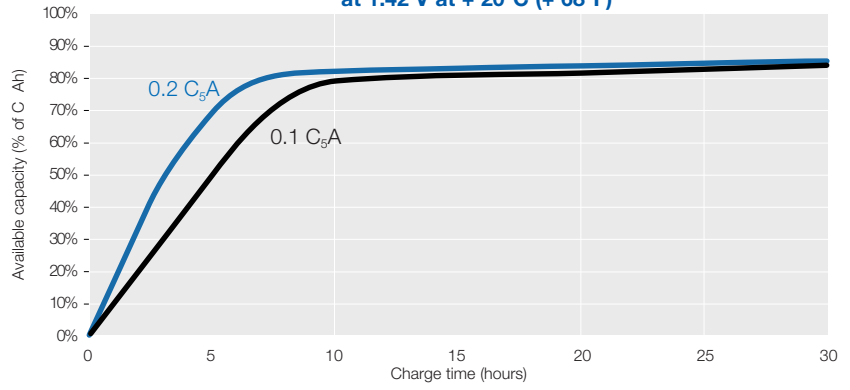

MC/MB Range – Available capacity after constant voltage charge at 1.40 V at + 20°C (+ 68°F)

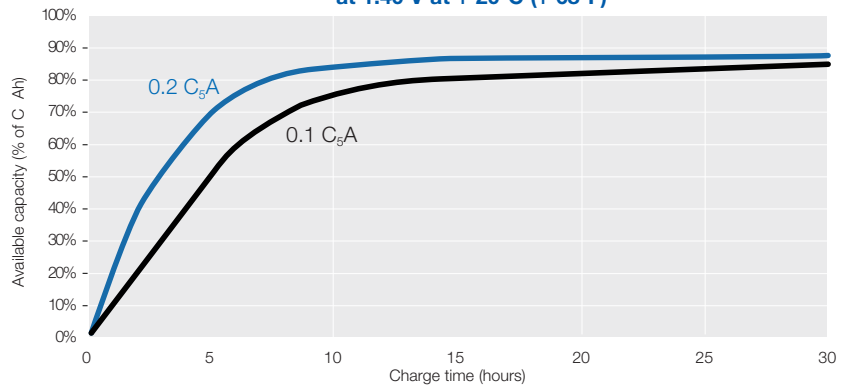

HC/HB Range – Available capacity after constant voltage charge at 1.40 V at + 20°C (+ 68°F)

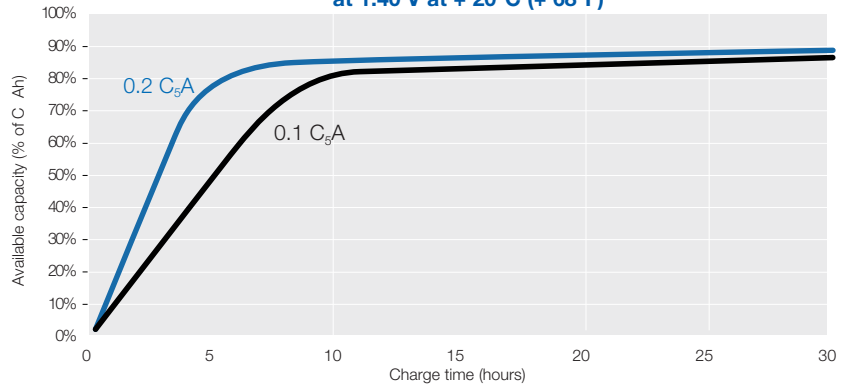

Alcad design and build to ensure long, **trouble-free battery life**

Alcad Single Cell batteries comply with the highest quality, safety and environmental standards

Electrical characteristics:

- Certified IEC 60623 5th edition - Secondary cells and batteries containing alkaline or other non-acid electrolytes - Vented nickel-cadmium prismatic rechargeable single cells.
- Verified discharge performance at high temperature (TH = +70°C) and low temperature (TL = -30°C)

Quality:

- ISO 9001 and ISO 14001
- Alcad World class continuous program.

Safety:

- Complies with EN 50272-2/ IEC 62485-2 - Safety requirements for secondary batteries and battery installations - Part 2: Stationary batteries

The protective covers for terminals and connectors, the insulated cables are compliant with IP2 level protection against electrical shocks according to safety standard.

- Complies with UL 1989 - Section 7: Flame arrester vent cap tests - UL standard for safety for standby batteries.

Environment & recycling:

- Fully recyclable
- RoHS – Although batteries and accumulators are not within the scope of the RoHS directive, Alcad has taken voluntary measures to make sure that the substances forbidden by RoHS are not present in the battery, with the exception of the electro-chemical core.
- REACH – Alcad has adopted internal procedures to ensure conformity with the European REACH (Registration, Evaluation, Authorisation and Restriction of Chemical Substances) Regulation.





A through-life service philosophy

Alcad's stationary battery specialists provide global expertise, with local customer service, through an expanding network of approved service stations in the Middle East, Asia, Europe and North America. You can depend on our support for the entire life of your battery, and beyond, including:

- installation, customer installation certification, commissioning and start-up
- preventive maintenance
- inspection, troubleshooting, testing and supervision
- corrective maintenance
- end of life removal, decommissioning and recycling
- training programmes for technicians and engineers

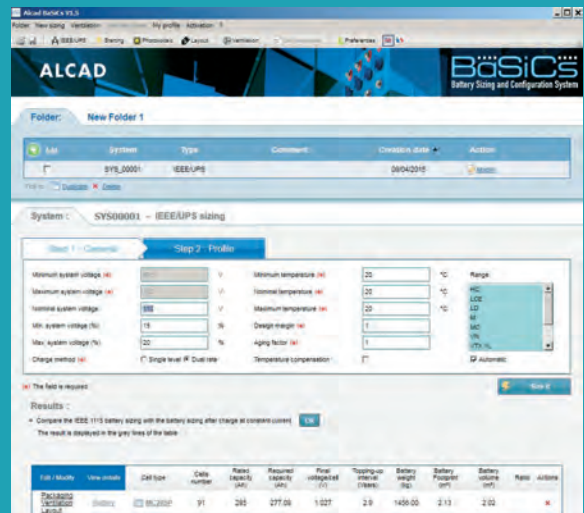

Size your battery solution

Our fast and easy to use Battery Sizing and Configuration System (BaSiCs) software support tool for stationary applications is available for download. This will help you find the right battery and create the optimum battery layout for your backup or starting application.

Search for 'BaSiCs' on our website

The best connection for optimum battery efficiency

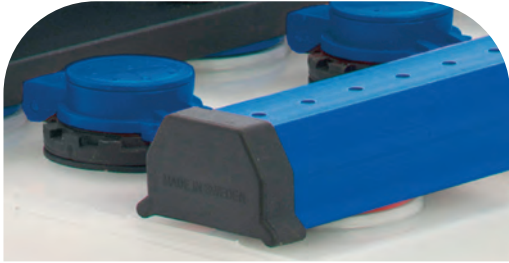

Standard layouts

Alcad has developed a series of standard layouts in which a battery may be ordered. Whether the battery is being installed on a rack, in a cabinet or is simply freestanding, the same configuration principles can be applied.

Two ways to configure the battery

	Normal connection	Crosswise connection
LCE/LBE	LCE10P to LCE375P	LBE400P to LBE1690P
MC/MB	MC9P to MC335P	MB350P to MB1440P
HC/HB	HC9P to HC210P	HB230P to HB920P

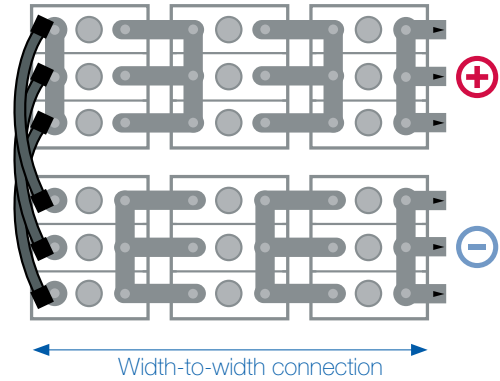
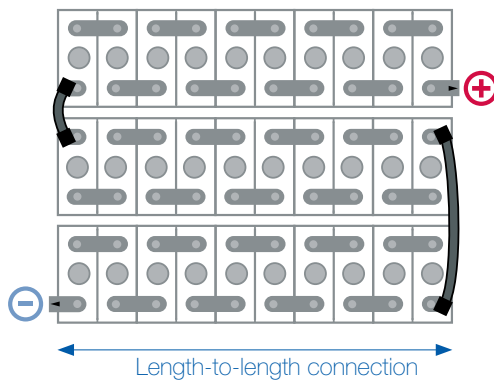

The cell is turned through 90° and then connected width-to-width – "crosswise" mounted. This minimises the installation's overall length. The cell's width is used to calculate the row length.





Dimensions

The dimensions of all available cell types are tabulated on the following pages.

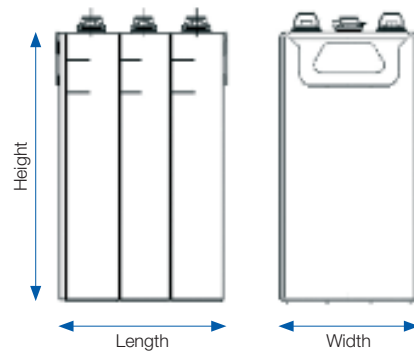

Notes:

- All the tabulated dimensions are maximum values.
- All the cell heights given in the tables include the height of the IP2X terminal cover.

Position of terminals

Single cells, 1 pole bolt per pole



LCE10P to LCE280P
MC9P to MC240P
HC9P to HC155P

Single cells, 2 pole bolts per pole



LCE300P to LCE375P
MC250P to MC335P
HC170P to HC210P

Single cells, with 2 - 6 pole bolts per pole

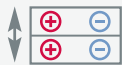

LBE400P to LBE550P
MB350P to MB480P
HB230P to HB305P



LBE600P to LBE830P
MB505P to MB720P
HB325P to HB460P



LBE890P to LBE1100P
MB740P to MB940P
HB510P to HB615P



LBE1150P to LBE1400P
MB1000P to MB1180P
HB640P to HB765P



LBE1450P to LBE1690P
MB1220P to MB1440P
HB800P to HB920P

Label naming information

LCE/LBE, MC/MB and HC/HB single cell ranges are respectively designated with a "-1" extension on ALCAD container labels. The "-1" extension designation refers to ALCAD single cell design for manufacturing purposes. As an example, 'LBE 750P' cell is named as 'LBE 750P-1' on the ALCAD container label.

Single Cell Range

LCE / LBE Range

Capacities and dimensions - **International System of units**

CONNECTION	Cell type	Capacity	Overall	Width	Length	Approx.	Approx.	Electrolyte per cell		Internal resistance	Cell connection bolt per pole
		C ₅ Ah	Height*	per cell	per cell	Weight per cell	electrolyte volume between level marks	Solid	Liquid		
		Ah	mm	mm	mm	Kg	cm ³	kg	L	mOhm	
NORMAL CONNECTION	LCE10P	10	270	121	42	1.60	146	0.26	0.80	10.5	M 6
	LCE15P	15	270	121	42	1.70	146	0.23	0.70	8.33	M 6
	LCE22P	22	270	121	42	1.90	143	0.23	0.70	4.77	M 6
	LCE30P	30	270	121	42	2.00	143	0.19	0.60	4.17	M 6
	LCE40P	40	270	121	66	3.10	235	0.36	1.10	3.13	M 6
	LCE47P	47	270	121	66	3.00	238	0.36	1.10	2.66	M 6
	LCE55P	55	270	121	66	3.30	235	0.32	1.00	2.27	M 6
	LCE62P	62	270	121	66	3.30	235	0.32	1.00	2.02	M 6
	LCE70P	70	357	192	68	6.10	540	0.87	2.70	2.29	M 8
	LCE75P	75	357	192	68	6.10	540	0.87	2.70	2.13	M 8
	LCE85P	85	357	192	68	6.80	530	0.78	2.40	1.88	M 10
	LCE90P	90	357	192	68	6.80	530	0.78	2.40	1.78	M 10
	LCE100P	100	357	192	68	6.80	530	0.78	2.40	1.60	M 10
	LCE110P	110	357	192	68	6.80	530	0.78	2.40	1.45	M 10
	LCE125P	125	357	192	68	7.40	530	0.68	2.10	1.28	M 10
	LCE145P	145	357	192	68	7.40	530	0.68	2.10	1.10	M 10
	LCE165P	165	357	192	93	9.80	750	1.04	3.20	0.97	M 10
	LCE185P	185	357	192	93	9.80	750	1.04	3.20	0.86	M 10
	LCE200P	200	357	192	93	10.4	740	0.94	2.90	0.80	M 10
	LCE220P	220	357	192	93	10.4	740	0.94	2.90	0.73	M 10
	LCE235P	235	413	192	93	11.6	750	1.20	3.70	0.70	M 10
	LCE255P	255	413	192	93	12.3	740	1.10	3.40	0.65	M 10
	LCE280P	280	413	192	93	12.3	740	1.10	3.40	0.59	M 10
	LCE300P	300	413	192	122	15.9	1000	1.56	4.80	0.55	2 x M 10
	LCE330P	330	413	192	122	15.9	1000	1.56	4.80	0.50	2 x M 10
LCE360P	360	413	192	122	16.6	990	1.43	4.40	0.46	2 x M 10	
LCE375P	375	413	192	122	16.6	990	1.43	4.40	0.44	2 x M 10	
CROSSWISE CONNECTION	LBE400P	400	406	195	146	18.0	1110	1.52	4.70	0.41	2 x M 10
	LBE415P	415	406	195	146	18.0	1110	1.52	4.70	0.40	2 x M 10
	LBE460P	460	406	195	159	19.8	1220	1.68	5.20	0.36	2 x M 10
	LBE500P	500	406	195	171	21.8	1320	1.81	5.60	0.33	2 x M 10
	LBE510P	510	406	195	171	21.8	1320	1.81	5.60	0.32	2 x M 10
	LBE550P	550	410	195	183	23.4	1430	1.94	6.00	0.30	2 x M 10
	LBE600P	600	410	195	206	26.1	1610	2.20	6.80	0.28	3 x M 10
	LBE650P	650	410	195	219	27.6	1720	2.37	7.30	0.25	3 x M 10
	LBE700P	700	410	195	232	29.4	1830	2.49	7.70	0.24	3 x M 10
	LBE750P	750	410	195	244	31.4	1930	2.62	8.10	0.22	3 x M 10
	LBE800P	800	410	195	256	33.4	2040	2.75	8.50	0.21	3 x M 10
	LBE830P	830	410	195	268	35.0	2140	2.88	8.90	0.20	3 x M 10
	LBE890P	890	410	195	292	37.2	2330	3.18	9.80	0.19	4 x M 10
	LBE925P	925	410	195	305	39.0	2440	3.34	10.3	0.18	4 x M 10
	LBE980P	980	410	195	317	41.0	2550	3.47	10.7	0.17	4 x M 10
	LBE1000P	1000	410	195	329	43.0	2650	3.60	11.1	0.17	4 x M 10
	LBE1020P	1020	410	195	329	43.0	2650	3.60	11.1	0.16	4 x M 10
	LBE1070P	1070	410	195	341	45.0	2750	3.73	11.5	0.15	4 x M 10
	LBE1100P	1100	410	195	353	46.6	2860	3.86	11.9	0.15	4 x M 10
	LBE1150P	1150	410	195	378	48.6	3050	4.18	12.9	0.14	5 x M 10
	LBE1200P	1200	410	195	390	50.6	3160	4.31	13.3	0.14	5 x M 10
	LBE1250P	1250	410	195	402	52.4	3260	4.41	13.6	0.13	5 x M 10
	LBE1300P	1300	410	195	413	54.8	3360	4.54	14.0	0.13	5 x M 10
	LBE1350P	1350	410	195	426	56.3	3470	4.67	14.4	0.12	5 x M 10
	LBE1400P	1400	410	195	438	58.2	3570	4.80	14.8	0.12	5 x M 10
LBE1450P	1450	410	195	463	59.9	3770	5.12	15.8	0.11	6 x M 10	
LBE1500P	1500	410	195	487	64.2	3980	5.38	16.6	0.11	6 x M 10	
LBE1550P	1550	410	195	499	65.9	4080	5.51	17.0	0.11	6 x M 10	
LBE1600P	1600	410	195	511	68.1	4190	5.64	17.4	0.10	6 x M 10	
LBE1660P	1660	410	195	523	69.8	4290	5.77	17.8	0.10	6 x M 10	
LBE1690P	1690	410	195	523	69.8	4290	5.77	17.8	0.10	6 x M 10	

* Height including the IP2X terminal cover

Single Cell Range

LCE / LBE Range

Capacities and dimensions - Imperial units

CONNECTION	Cell type	Capacity	Overall	Width	Length	Approx.	Approx.	Electrolyte per cell		Internal resistance	Cell connection bolt per pole
		C _s Ah	Height*	per cell	per cell	Weight per cell	electrolyte volume between level marks	Solid	Liquid		
		Ah	in	in	in	lbs	in ³	lbs	US Gal.		
NORMAL CONNECTION	LCE10P	10	10.6	4.76	1.65	3.53	8.91	0.57	0.21	10.5	M 6
	LCE15P	15	10.6	4.76	1.65	3.75	8.91	0.50	0.18	8.33	M 6
	LCE22P	22	10.6	4.76	1.65	4.19	8.73	0.50	0.18	4.77	M 6
	LCE30P	30	10.6	4.76	1.65	4.41	8.73	0.43	0.16	4.17	M 6
	LCE40P	40	10.6	4.76	2.60	6.83	14.3	0.79	0.29	3.13	M 6
	LCE47P	47	10.6	4.76	2.60	6.61	14.5	0.79	0.29	2.66	M 6
	LCE55P	55	10.6	4.76	2.60	7.28	14.3	0.71	0.26	2.27	M 6
	LCE62P	62	10.6	4.76	2.60	7.28	14.3	0.71	0.26	2.02	M 6
	LCE70P	70	14.1	7.56	2.68	13.4	33.0	1.93	0.71	2.29	M 8
	LCE75P	75	14.1	7.56	2.68	13.4	33.0	1.93	0.71	2.13	M 8
	LCE85P	85	14.1	7.56	2.68	15.0	32.3	1.71	0.63	1.88	M 10
	LCE90P	90	14.1	7.56	2.68	15.0	32.3	1.71	0.63	1.78	M 10
	LCE100P	100	14.1	7.56	2.68	15.0	32.3	1.71	0.63	1.60	M 10
	LCE110P	110	14.1	7.56	2.68	15.0	32.3	1.71	0.63	1.45	M 10
	LCE125P	125	14.1	7.56	2.68	16.3	32.3	1.50	0.55	1.28	M 10
	LCE145P	145	14.1	7.56	2.68	16.3	32.3	1.50	0.55	1.10	M 10
	LCE165P	165	14.1	7.56	3.66	21.6	45.8	2.29	0.85	0.97	M 10
	LCE185P	185	14.1	7.56	3.66	21.6	45.8	2.29	0.85	0.86	M 10
	LCE200P	200	14.1	7.56	3.66	22.9	45.2	2.07	0.77	0.80	M 10
	LCE220P	220	14.1	7.56	3.66	22.9	45.2	2.07	0.77	0.73	M 10
LCE235P	235	16.3	7.56	3.66	25.6	45.8	2.64	0.98	0.70	M 10	
LCE255P	255	16.3	7.56	3.66	27.1	45.2	2.43	0.90	0.65	M 10	
LCE280P	280	16.3	7.56	3.66	27.1	45.2	2.43	0.90	0.59	M 10	
LCE300P	300	16.3	7.56	4.80	35.1	61.0	3.43	1.27	0.55	2 x M 10	
LCE330P	330	16.3	7.56	4.80	35.1	61.0	3.43	1.27	0.50	2 x M 10	
LCE360P	360	16.3	7.56	4.80	36.6	60.4	3.14	1.16	0.46	2 x M 10	
LCE375P	375	16.3	7.56	4.80	36.6	60.4	3.14	1.16	0.44	2 x M 10	
CROSSWISE CONNECTION	LBE400P	400	16.0	7.68	5.75	39.7	67.7	3.36	1.24	0.41	2 x M 10
	LBE415P	415	16.0	7.68	5.75	39.7	67.7	3.36	1.24	0.40	2 x M 10
	LBE460P	460	16.0	7.68	6.26	43.7	74.4	3.71	1.37	0.36	2 x M 10
	LBE500P	500	16.0	7.68	6.73	48.1	80.6	4.00	1.48	0.33	2 x M 10
	LBE510P	510	16.0	7.68	6.73	48.1	80.6	4.00	1.48	0.32	2 x M 10
	LBE550P	550	16.1	7.68	7.20	51.6	87.3	4.29	1.59	0.30	2 x M 10
	LBE600P	600	16.1	7.68	8.11	57.5	98.2	4.86	1.80	0.28	3 x M 10
	LBE650P	650	16.1	7.68	8.62	60.8	105	5.21	1.93	0.25	3 x M 10
	LBE700P	700	16.1	7.68	9.13	64.8	112	5.50	2.03	0.24	3 x M 10
	LBE750P	750	16.1	7.68	9.61	69.2	118	5.79	2.14	0.22	3 x M 10
	LBE800P	800	16.1	7.68	10.1	73.6	124	6.07	2.25	0.21	3 x M 10
	LBE830P	830	16.1	7.68	10.6	77.2	131	6.36	2.35	0.20	3 x M 10
	LBE890P	890	16.1	7.68	11.5	82.0	142	7.00	2.59	0.19	4 x M 10
	LBE925P	925	16.1	7.68	12.0	86.0	149	7.36	2.72	0.18	4 x M 10
	LBE980P	980	16.1	7.68	12.5	90.4	156	7.64	2.83	0.17	4 x M 10
	LBE1000P	1000	16.1	7.68	13.0	94.8	162	7.93	2.93	0.17	4 x M 10
	LBE1020P	1020	16.1	7.68	13.0	94.8	162	7.93	2.93	0.16	4 x M 10
	LBE1070P	1070	16.1	7.68	13.4	99.2	168	8.21	3.04	0.15	4 x M 10
	LBE1100P	1100	16.1	7.68	13.9	103	175	8.50	3.14	0.15	4 x M 10
	LBE1150P	1150	16.1	7.68	14.9	107	186	9.21	3.41	0.14	5 x M 10
	LBE1200P	1200	16.1	7.68	15.4	112	193	9.50	3.51	0.14	5 x M 10
	LBE1250P	1250	16.1	7.68	15.8	116	199	9.71	3.59	0.13	5 x M 10
	LBE1300P	1300	16.1	7.68	16.3	121	205	10.0	3.70	0.13	5 x M 10
	LBE1350P	1350	16.1	7.68	16.8	124	212	10.3	3.80	0.12	5 x M 10
	LBE1400P	1400	16.1	7.68	17.2	128	218	10.6	3.91	0.12	5 x M 10
	LBE1450P	1450	16.1	7.68	18.2	132	230	11.3	4.17	0.11	6 x M 10
LBE1500P	1500	16.1	7.68	19.2	142	243	11.9	4.39	0.11	6 x M 10	
LBE1550P	1550	16.1	7.68	19.6	145	249	12.1	4.49	0.11	6 x M 10	
LBE1600P	1600	16.1	7.68	20.1	150	256	12.4	4.60	0.10	6 x M 10	
LBE1660P	1660	16.1	7.68	20.6	154	262	12.7	4.70	0.10	6 x M 10	
LBE1690P	1690	16.1	7.68	20.6	154	262	12.7	4.70	0.10	6 x M 10	

* Height including the IP2X terminal cover

Single Cell Range

LCE / LBE Range

Performance after prolonged float charge of fully charged cells
Available Amperes at + 20°C ± 5°C (+ 68°F ± 9°F)

Final voltage: 1.00 V/cell

Cell type	Capacity C ₅ Ah	Hours								Minutes						Seconds		
		Ah	10	8	5	3	2	1.5	1	30	20	15	10	5	1	30	5	1
LCE10P	10	1.03	1.27	2.00	3.23	4.37	5.44	6.96	8.50	9.53	10.2	11.2	13.9	16.5	18.3	20.7	21.2	
LCE15P	15	1.54	1.91	3.00	4.80	6.45	8.00	10.6	14.2	16.0	17.4	18.7	23.7	26.8	29.7	38.3	43.1	
LCE22P	22	2.26	2.81	4.40	7.04	9.50	11.7	15.5	20.8	23.5	25.5	27.4	34.7	39.3	43.6	56.1	63.3	
LCE30P	30	3.08	3.83	6.00	9.60	12.9	16.0	21.2	28.4	32.1	34.8	37.4	47.3	53.6	59.5	76.5	86.3	
LCE40P	40	4.10	5.10	8.00	12.8	17.2	21.3	28.3	37.8	42.8	46.4	49.9	63.1	71.4	79.3	102	115	
LCE47P	47	4.82	5.99	9.40	15.0	20.2	25.1	33.2	44.5	50.3	54.5	58.6	74.1	83.9	93.2	120	135	
LCE55P	55	5.64	7.01	11.0	17.6	23.6	29.3	38.9	52.0	58.8	63.8	68.6	86.7	98.2	109	140	158	
LCE62P	62	6.36	7.91	12.4	19.8	26.6	33.0	43.8	58.7	66.3	71.9	77.4	97.8	111	123	158	178	
LCE70P	70	7.07	8.84	14.0	22.4	30.4	36.9	47.5	60.7	68.6	72.8	76.9	92.4	105	113	144	160	
LCE75P	75	7.58	9.47	15.0	24.0	32.6	39.6	50.9	65.1	73.5	78.0	82.3	99.0	113	121	154	171	
LCE85P	85	8.59	10.7	17.0	27.2	36.9	44.8	57.7	73.8	83.2	88.4	93.3	112	128	137	175	194	
LCE90P	90	9.10	11.4	18.0	28.8	39.1	47.5	61.1	78.1	88.1	93.6	98.8	119	136	145	185	205	
LCE100P	100	10.1	12.6	20.0	32.0	43.4	52.8	67.9	86.8	97.9	104	110	132	151	161	205	228	
LCE110P	110	11.1	13.9	22.0	35.2	47.8	58.0	74.7	95.5	108	114	121	145	166	177	226	251	
LCE125P	125	12.6	15.8	25.0	40.0	54.3	66.0	84.9	108	122	130	137	165	188	202	257	285	
LCE145P	145	14.7	18.3	29.0	46.4	63.0	76.5	98.5	126	142	151	159	191	218	234	298	331	
LCE165P	165	16.7	20.8	33.0	52.8	71.7	87.1	112	143	162	172	181	218	249	266	339	376	
LCE185P	185	18.7	23.4	37.0	59.2	80.4	97.6	126	161	181	192	203	244	279	298	380	422	
LCE200P	200	20.2	25.3	40.0	64.0	86.9	106	136	174	196	208	220	264	301	323	411	456	
LCE220P	220	22.2	27.8	44.0	70.4	95.6	116	149	191	215	229	242	290	331	355	452	502	
LCE235P	235	24.2	29.9	47.0	75.2	100	121	155	200	224	240	258	296	329	353	423	455	
LCE255P	255	26.3	32.5	51.0	81.6	109	131	168	217	243	261	280	322	357	383	459	493	
LCE280P	280	28.9	35.7	56.0	89.6	120	144	184	238	267	286	308	353	392	420	504	542	
LCE300P	300	30.9	38.2	60.0	96.0	128	154	198	255	286	307	330	378	420	450	540	580	
LCE330P	330	34.0	42.0	66.0	106	141	170	217	280	314	338	363	416	462	495	594	638	
LCE360P	360	37.1	45.9	72.0	115	154	185	237	306	343	368	396	454	504	540	648	697	
LCE375P	375	38.6	47.8	75.0	120	160	193	247	319	357	384	412	473	525	563	675	726	
LBE400P	400	41.2	51.0	80.0	128	171	206	263	340	381	409	440	504	560	600	720	774	
LBE415P	415	42.8	52.9	83.0	133	177	213	273	352	395	424	456	523	581	623	747	803	
LBE460P	460	47.4	58.6	92.0	147	196	236	303	391	438	471	506	580	644	690	828	890	
LBE500P	500	51.5	63.7	100.0	160	214	257	329	425	476	511	550	630	700	750	900	967	
LBE510P	510	52.6	65.0	102	163	218	262	336	433	486	522	561	643	714	765	918	987	
LBE550P	550	56.7	70.1	110	176	235	283	362	467	524	563	605	693	770	825	990	1064	
LBE600P	600	61.8	76.4	120	192	256	308	395	510	571	614	660	757	840	900	1080	1161	
LBE650P	650	67.0	82.8	130	208	278	334	428	552	619	665	715	820	910	975	1170	1258	
LBE700P	700	72.1	89.2	140	224	299	360	461	595	667	716	770	883	980	1050	1260	1354	
LBE750P	750	77.3	95.5	150	240	320	386	494	637	714	767	825	946	1050	1125	1350	1451	
LBE800P	800	82.4	102	160	256	342	411	527	679	762	818	879	1009	1120	1200	1440	1548	
LBE830P	830	85.5	106	166	266	354	427	547	705	791	849	912	1046	1162	1245	1494	1606	
LBE890P	890	91.7	113	178	285	380	458	586	756	848	910	978	1122	1246	1335	1602	1722	
LBE925P	925	95.3	118	185	296	395	476	609	786	881	946	1017	1166	1295	1388	1665	1790	
LBE980P	980	101	125	196	314	418	504	646	832	933	1002	1077	1236	1372	1470	1764	1896	
LBE1000P	1000	103	127	200	320	427	514	659	849	952	1023	1099	1261	1400	1500	1800	1935	
LBE1020P	1020	105	130	204	326	436	524	672	866	972	1043	1121	1286	1428	1530	1836	1973	
LBE1070P	1070	110	136	214	342	457	550	705	909	1019	1094	1176	1349	1498	1605	1926	2070	
LBE1100P	1100	113	140	220	352	470	566	725	934	1048	1125	1209	1387	1540	1650	1980	2128	
LBE1150P	1150	119	147	230	368	491	591	758	977	1095	1176	1264	1450	1610	1725	2070	2225	
LBE1200P	1200	124	153	240	384	512	617	790	1019	1143	1227	1319	1513	1680	1800	2160	2322	
LBE1250P	1250	129	159	250	400	534	643	823	1062	1191	1279	1374	1576	1750	1875	2250	2418	
LBE1300P	1300	134	166	260	416	555	668	856	1104	1238	1330	1429	1639	1820	1950	2340	2515	
LBE1350P	1350	139	172	270	432	576	694	889	1147	1286	1381	1484	1702	1890	2025	2430	2612	
LBE1400P	1400	144	178	280	448	598	720	922	1189	1333	1432	1539	1765	1960	2100	2520	2709	
LBE1450P	1450	149	185	290	464	619	745	955	1232	1381	1483	1594	1828	2030	2175	2610	2805	
LBE1500P	1500	155	191	300	480	641	771	988	1274	1429	1534	1649	1891	2100	2250	2700	2902	
LBE1550P	1550	160	197	310	496	662	797	1021	1316	1476	1585	1704	1954	2170	2325	2790	2999	
LBE1600P	1600	165	204	320	512	683	823	1054	1359	1524	1637	1759	2017	2240	2400	2880	3096	
LBE1660P	1660	171	211	332	531	709	853	1093	1410	1581	1698	1825	2093	2324	2490	2988	3212	
LBE1690P	1690	174	215	338	541	722	869	1113	1435	1610	1729	1858	2131	2366	2535	3042	3270	

Single Cell Range

LCE / LBE Range

Performance after prolonged float charge of fully charged cells
Available Amperes at + 20°C ± 5°C (+ 68°F ± 9°F)

Final voltage: 1.05 V/cell

Cell type	Capacity C ₅ Ah	Hours							Minutes						Seconds		
		10	8	5	3	2	1.5	1	30	20	15	10	5	1	30	5	1
LCE10P	10	1.03	1.27	1.99	2.89	3.99	4.79	5.86	7.52	8.44	9.09	10.0	11.1	13.7	14.8	17.1	17.7
LCE15P	15	1.53	1.89	2.94	4.65	5.78	6.87	8.98	12.1	14.1	15.2	16.8	17.1	21.6	24.3	31.7	35.6
LCE22P	22	2.24	2.78	4.31	6.82	8.48	10.1	13.2	17.7	20.7	22.3	24.6	25.0	31.7	35.6	46.4	52.3
LCE30P	30	3.06	3.79	5.88	9.30	11.6	13.7	18.0	24.1	28.2	30.3	33.6	34.1	43.2	48.5	63.3	71.3
LCE40P	40	4.08	5.05	7.84	12.4	15.4	18.3	23.9	32.2	37.6	40.5	44.8	45.5	57.6	64.7	84.4	95.0
LCE47P	47	4.79	5.93	9.21	14.6	18.1	21.5	28.1	37.8	44.1	47.5	52.6	53.5	67.7	76.0	99.2	112
LCE55P	55	5.61	6.94	10.8	17.1	21.2	25.2	32.9	44.2	51.7	55.6	61.6	62.6	79.2	89.0	116	131
LCE62P	62	6.32	7.83	12.2	19.2	23.9	28.4	37.1	49.9	58.2	62.7	69.4	70.5	89.3	100	131	147
LCE70P	70	7.00	8.75	13.7	21.9	26.9	31.6	39.2	51.4	58.4	62.4	67.7	73.0	84.7	93.3	119	131
LCE75P	75	7.50	9.38	14.7	23.5	28.8	33.9	42.0	55.1	62.6	66.9	72.5	78.2	90.7	100	127	140
LCE85P	85	8.50	10.6	16.7	26.6	32.6	38.4	47.5	62.4	71.0	75.8	82.2	88.6	103	113	144	159
LCE90P	90	9.00	11.3	17.6	28.2	34.6	40.6	50.3	66.1	75.1	80.2	87.0	93.8	109	120	152	168
LCE100P	100	10.0	12.5	19.6	31.3	38.4	45.1	55.9	73.4	83.48	89.2	96.7	104	121	133	169	187
LCE110P	110	11.0	13.8	21.6	34.5	42.2	49.7	61.5	80.8	91.83	98.1	106	115	133	147	186	205
LCE125P	125	12.5	15.6	24.5	39.2	48.0	56.4	69.9	91.8	104	111	121	130	151	167	212	233
LCE145P	145	14.5	18.1	28.4	45.4	55.7	65.4	81.1	106	121	129	140	151	175	193	246	271
LCE165P	165	16.5	20.6	32.3	51.7	63.4	74.5	92.3	121	138	147	160	172	200	220	279	308
LCE185P	185	18.5	23.1	36.3	58.0	71.0	83.5	103	136	154	165	179	193	224	247	313	345
LCE200P	200	20.0	25.0	39.2	62.7	76.8	90.3	112	147	167	178	193	209	242	267	339	373
LCE220P	220	22.0	27.5	43.1	68.9	84.5	99.3	123	162	184	196	213	229	266	293	373	411
LCE235P	235	24.0	29.8	46.5	72.9	90.9	104	129	169	187	194	215	245	265	289	347	377
LCE255P	255	26.1	32.4	50.4	79.1	98.7	113	141	183	202	210	233	266	287	314	377	409
LCE280P	280	28.6	35.5	55.4	86.8	108	124	154	201	222	231	256	292	315	345	414	449
LCE300P	300	30.7	38.1	59.3	93.0	116	132	165	216	238	247	274	313	338	369	443	481
LCE330P	330	33.7	41.9	65.3	102	128	146	182	237	262	272	302	345	372	406	488	529
LCE360P	360	36.8	45.7	71.2	112	139	159	198	259	286	297	329	376	405	443	532	578
LCE375P	375	38.3	47.6	74.2	116	145	166	207	269	298	309	343	392	422	461	554	602
LBE400P	400	40.9	50.8	79.1	124	155	177	220	287	318	329	366	418	450	492	591	642
LBE415P	415	42.4	52.7	82.1	129	161	183	229	298	329	342	380	433	467	511	613	666
LBE460P	460	47.0	58.4	91.0	143	178	203	253	330	365	379	421	480	518	566	680	738
LBE500P	500	51.1	63.5	98.9	155	193	221	276	359	397	412	457	522	563	615	739	802
LBE510P	510	52.1	64.7	101	158	197	225	281	366	405	420	467	533	574	628	754	818
LBE550P	550	56.2	69.8	109	171	213	243	303	395	437	453	503	574	619	677	813	882
LBE600P	600	61.3	76.2	119	186	232	265	331	431	476	494	549	626	676	738	887	963
LBE650P	650	66.4	82.5	129	202	252	287	358	467	516	535	595	679	732	800	961	1043
LBE700P	700	71.5	88.9	138	217	271	309	386	503	556	577	640	731	788	861	1035	1123
LBE750P	750	76.6	95.2	148	233	290	331	413	539	595	618	686	783	845	923	1109	1203
LBE800P	800	81.7	102	158	248	310	353	441	575	635	659	732	835	901	984	1183	1283
LBE830P	830	84.8	105	164	257	321	366	457	596	659	684	759	867	935	1021	1227	1332
LBE890P	890	90.9	113	176	276	344	393	490	639	707	733	814	929	1002	1095	1316	1428
LBE925P	925	94.5	117	183	287	358	408	510	665	734	762	846	966	1042	1138	1367	1484
LBE980P	980	100	124	194	304	379	433	540	704	778	807	896	1023	1104	1206	1449	1572
LBE1000P	1000	102	127	198	310	387	442	551	718	794	824	915	1044	1126	1230	1478	1604
LBE1020P	1020	104	129	202	316	395	450	562	733	810	840	933	1065	1149	1255	1508	1636
LBE1070P	1070	109	136	212	332	414	472	590	769	850	881	979	1117	1205	1317	1582	1717
LBE1100P	1100	112	140	218	341	426	486	606	790	873	906	1006	1149	1239	1353	1626	1765
LBE1150P	1150	118	146	228	357	445	508	634	826	913	947	1052	1201	1295	1415	1700	1845
LBE1200P	1200	123	152	237	372	464	530	661	862	953	988	1098	1253	1351	1477	1774	1925
LBE1250P	1250	128	159	247	388	484	552	689	898	992	1030	1143	1305	1408	1538	1848	2005
LBE1300P	1300	133	165	257	403	503	574	716	934	1032	1071	1189	1357	1464	1600	1922	2086
LBE1350P	1350	138	171	267	419	522	596	744	970	1072	1112	1235	1410	1520	1661	1996	2166
LBE1400P	1400	143	178	277	434	542	618	771	1006	1112	1153	1281	1462	1577	1723	2070	2246
LBE1450P	1450	148	184	287	450	561	640	799	1042	1151	1194	1326	1514	1633	1784	2143	2326
LBE1500P	1500	153	190	297	465	580	662	827	1078	1191	1236	1372	1566	1689	1846	2217	2407
LBE1550P	1550	158	197	307	481	600	684	854	1114	1231	1277	1418	1618	1745	1907	2291	2487
LBE1600P	1600	163	203	317	496	619	706	882	1149	1270	1318	1464	1671	1802	1969	2365	2567
LBE1660P	1660	170	211	328	515	642	733	915	1193	1318	1367	1519	1733	1869	2043	2454	2663
LBE1690P	1690	173	215	334	524	654	746	931	1214	1342	1392	1546	1765	1903	2079	2498	2711

Single Cell Range

LCE / LBE Range

Performance after prolonged float charge of fully charged cells
Available Amperes at + 20°C ± 5°C (+ 68°F ± 9°F)

Final voltage: 1.10 V/cell

Cell type	Capacity C ₅ Ah	Hours							Minutes						Seconds		
		Ah	10	8	5	3	2	1.5	1	30	20	15	10	5	1	30	5
LCE10P	10	1.00	1.20	1.75	2.80	3.63	4.24	4.79	6.26	7.03	7.54	8.19	9.49	11.1	12.1	13.5	13.9
LCE15P	15	1.50	1.84	2.82	4.01	5.11	6.09	7.19	9.6	10.7	11.4	12.8	15.1	17.4	20.0	26.2	29.7
LCE22P	22	2.20	2.70	4.14	5.89	7.49	8.94	10.5	14.2	15.7	16.8	18.7	22.1	25.6	29.4	38.4	43.6
LCE30P	30	3.00	3.68	5.65	8.03	10.2	12.2	14.4	19.3	21.5	22.9	25.5	30.1	34.9	40.1	52.4	59.5
LCE40P	40	4.00	4.90	7.53	10.7	13.6	16.2	19.2	25.7	28.6	30.5	34.0	40.2	46.5	53.4	69.8	79.3
LCE47P	47	4.70	5.76	8.85	12.6	16.0	19.1	22.5	30.2	33.6	35.8	40.0	47.2	54.6	62.7	82.0	93.2
LCE55P	55	5.50	6.74	10.4	14.7	18.7	22.3	26.4	35.4	39.4	41.9	46.8	55.3	63.9	73.4	96.0	109
LCE62P	62	6.20	7.60	11.7	16.6	21.1	25.2	29.7	39.9	44.4	47.3	52.8	62.3	72.1	82.8	108	123
LCE70P	70	6.93	8.49	13.1	18.7	23.6	27.7	32.4	41.5	45.7	46.4	51.1	60.3	68.5	76.6	96	107
LCE75P	75	7.43	9.10	14.0	20.0	25.3	29.7	34.7	44.4	49.0	49.7	54.7	64.6	73.4	82.1	103	115
LCE85P	85	8.42	10.3	15.9	22.7	28.6	33.6	39.3	50.4	55.5	56.3	62.0	73.2	83.2	93.0	117	130
LCE90P	90	8.92	10.9	16.8	24.0	30.3	35.6	41.6	53.3	58.8	59.6	65.7	77.5	88.1	98.5	124	138
LCE100P	100	9.91	12.1	18.7	26.7	33.7	39.5	46.3	59.2	65.3	66.3	73.0	86.1	97.9	109	137	153
LCE110P	110	10.9	13.3	20.5	29.3	37.0	43.5	50.9	65.2	71.8	72.9	80.3	94.7	108	120	151	169
LCE125P	125	12.4	15.2	23.3	33.3	42.1	49.4	57.8	74.1	81.6	82.8	91.2	108	122	137	172	192
LCE145P	145	14.4	17.6	27.1	38.7	48.8	57.3	67.1	85.9	94.7	96.1	106	125	142	159	199	222
LCE165P	165	16.3	20.0	30.8	44.0	55.6	65.2	76.3	97.8	108	109	120	142	161	181	227	253
LCE185P	185	18.3	22.4	34.5	49.3	62.3	73.1	85.6	110	121	123	135	159	181	203	254	284
LCE200P	200	19.8	24.3	37.3	53.3	67.4	79.1	92.5	118	131	133	146	172	196	219	275	307
LCE220P	220	21.8	26.7	41.1	58.7	74.1	87.0	102	130	144	146	161	189	215	241	302	337
LCE235P	235	23.5	28.8	44.2	61.3	77.0	88.7	105	131	142	156	171	180	216	235	286	314
LCE255P	255	25.5	31.3	48.0	66.5	83.5	96.3	114	143	154	169	186	195	234	255	310	340
LCE280P	280	28.0	34.3	52.7	73.0	91.7	106	125	157	169	186	204	215	257	280	341	374
LCE300P	300	30.0	36.8	56.5	78.3	98.3	113	134	168	181	199	219	230	275	300	365	400
LCE330P	330	33.0	40.5	62.1	86.1	108	125	147	185	199	219	241	253	303	330	402	440
LCE360P	360	36.0	44.1	67.8	93.9	118	136	160	201	218	239	263	276	330	360	438	481
LCE375P	375	37.5	46.0	70.6	97.8	123	142	167	210	227	249	274	287	344	375	457	501
LBE400P	400	40.0	49.0	75.3	104	131	151	178	224	242	265	292	306	367	400	487	534
LBE415P	415	41.5	50.9	78.1	108	136	157	185	232	251	275	303	318	381	415	505	554
LBE460P	460	46.0	56.4	86.6	120	151	174	205	257	278	305	336	352	422	460	560	614
LBE500P	500	50.0	61.3	94.1	130	164	189	223	280	302	331	365	383	459	500	609	667
LBE510P	510	51.0	62.5	96.0	133	167	193	227	285	308	338	372	391	468	510	621	681
LBE550P	550	55.0	67.4	104	143	180	208	245	308	332	364	401	421	505	550	670	734
LBE600P	600	60.0	73.6	113	157	197	226	267	336	363	398	438	460	550	600	730	801
LBE650P	650	65.0	79.7	122	170	213	245	289	364	393	431	474	498	596	650	791	868
LBE700P	700	70.0	85.8	132	183	229	264	312	392	423	464	511	536	642	700	852	934
LBE750P	750	75.0	92.0	141	196	246	283	334	420	453	497	547	575	688	750	913	1001
LBE800P	800	80.0	98	151	209	262	302	356	447	483	530	584	613	734	800	974	1068
LBE830P	830	83.0	102	156	217	272	313	370	464	501	550	606	636	761	830	1010	1108
LBE890P	890	89.0	109	168	232	292	336	396	498	538	590	649	682	816	890	1083	1188
LBE925P	925	92.5	113	174	241	303	349	412	517	559	613	675	709	849	925	1126	1235
LBE980P	980	98	120	184	256	321	370	436	548	592	649	715	751	899	980	1193	1308
LBE1000P	1000	100	123	188	261	328	377	445	559	604	663	730	766	917	1000	1217	1335
LBE1020P	1020	102	125	192	266	334	385	454	571	616	676	744	781	936	1020	1242	1361
LBE1070P	1070	107	131	201	279	351	404	477	599	646	709	781	820	982	1070	1303	1428
LBE1100P	1100	110	135	207	287	360	415	490	615	665	729	803	843	1009	1100	1339	1468
LBE1150P	1150	115	141	217	300	377	434	512	643	695	762	839	881	1055	1150	1400	1535
LBE1200P	1200	120	147	226	313	393	453	534	671	725	795	876	919	1101	1200	1461	1602
LBE1250P	1250	125	153	235	326	410	472	557	699	755	828	912	958	1147	1250	1522	1668
LBE1300P	1300	130	159	245	339	426	491	579	727	785	862	948	996	1193	1300	1583	1735
LBE1350P	1350	135	166	254	352	442	510	601	755	816	895	985	1034	1238	1350	1643	1802
LBE1400P	1400	140	172	264	365	459	528	624	783	846	928	1021	1073	1284	1400	1704	1869
LBE1450P	1450	145	178	273	378	475	547	646	811	876	961	1058	1111	1330	1450	1765	1935
LBE1500P	1500	150	184	282	391	491	566	668	839	906	994	1094	1149	1376	1500	1826	2002
LBE1550P	1550	155	190	292	404	508	585	690	867	937	1027	1131	1187	1422	1550	1887	2069
LBE1600P	1600	160	196	301	417	524	604	713	895	967	1060	1167	1226	1468	1600	1948	2136
LBE1660P	1660	166	204	313	433	544	627	739	929	1003	1100	1211	1272	1523	1660	2021	2216
LBE1690P	1690	169	207	318	441	554	638	753	945	1021	1120	1233	1295	1550	1690	2057	2256

Single Cell Range

LCE / LBE Range

Performance after prolonged float charge of fully charged cells
Available Amperes at + 20°C ± 5°C (+ 68°F ± 9°F)

Final voltage: 1.14 V/cell

Cell type	Capacity C ₅ Ah	Hours							Minutes							Seconds		
		Ah	10	8	5	3	2	1.5	1	30	20	15	10	5	1	30	5	1
LCE10P	10	0.99	1.15	1.53	2.54	3.16	3.49	3.94	5.05	5.69	6.00	6.68	8.03	9.01	9.61	11.3	11.6	
LCE15P	15	1.47	1.73	2.48	3.53	4.38	4.92	5.91	7.58	8.53	9.18	9.66	11.0	14.3	16.5	21.6	24.8	
LCE22P	22	2.16	2.54	3.64	5.17	6.42	7.21	8.67	11.1	12.5	13.5	14.2	16.2	20.9	24.2	31.7	36.4	
LCE30P	30	2.94	3.46	4.97	7.05	8.76	9.83	11.8	15.2	17.1	18.4	19.3	22.1	28.5	33.0	43.3	49.6	
LCE40P	40	3.92	4.61	6.62	9.40	11.7	13.1	15.8	20.2	22.8	24.5	25.8	29.4	38.0	44.0	57.7	66.1	
LCE47P	47	4.61	5.42	7.78	11.0	13.7	15.4	18.5	23.7	26.7	28.8	30.3	34.6	44.7	51.7	67.8	77.7	
LCE55P	55	5.39	6.34	9.10	12.9	16.1	18.0	21.7	27.8	31.3	33.7	35.4	40.5	52.3	60.5	79.3	90.9	
LCE62P	62	6.08	7.15	10.3	14.6	18.1	20.3	24.4	31.3	35.3	37.9	39.9	45.6	58.9	68.2	89.4	102	
LCE70P	70	6.72	7.90	11.5	16.1	19.8	22.1	25.4	32.0	36.5	36.6	41.9	45.1	56.0	62.0	79.4	89.6	
LCE75P	75	7.20	8.46	12.3	17.2	21.3	23.7	27.2	34.3	39.1	39.3	44.9	48.3	60.0	66.4	85.1	96.0	
LCE85P	85	8.16	9.59	13.9	19.5	24.1	26.9	30.8	38.9	44.3	44.5	50.8	54.8	68.0	75.3	96.4	109	
LCE90P	90	8.64	10.2	14.8	20.6	25.5	28.5	32.6	41.2	46.9	47.1	53.8	58.0	72.0	79.7	102	115	
LCE100P	100	9.60	11.3	16.4	22.9	28.4	31.6	36.3	45.8	52.2	52.3	59.8	64.4	80.0	88.5	113	128	
LCE110P	110	10.6	12.4	18.0	25.2	31.2	34.8	39.9	50.4	57.4	57.6	65.8	70.9	88.0	97.4	125	141	
LCE125P	125	12.0	14.1	20.5	28.7	35.4	39.6	45.3	57.2	65.2	65.4	74.8	80.5	100	111	142	160	
LCE145P	145	13.9	16.4	23.8	33.3	41.1	45.9	52.6	66.4	75.6	75.9	86.7	93.4	116	128	165	186	
LCE165P	165	15.8	18.6	27.1	37.8	46.8	52.2	59.9	75.5	86.1	86.4	98.7	106	132	146	187	211	
LCE185P	185	17.8	20.9	30.3	42.4	52.5	58.5	67.1	84.7	96.5	96.8	111	119	148	164	210	237	
LCE200P	200	19.2	22.6	32.8	45.9	56.7	63.3	72.5	91.6	104	105	120	129	160	177	227	256	
LCE220P	220	21.1	24.8	36.1	50.5	62.4	69.6	79.8	101	115	115	132	142	176	195	250	282	
LCE235P	235	23.0	27.1	38.9	53.1	63.7	70.6	81.4	104	111	116	130	151	176	192	239	265	
LCE255P	255	24.9	29.4	42.2	57.7	69.2	76.6	88.3	113	121	125	141	164	191	208	259	287	
LCE280P	280	27.4	32.3	46.4	63.3	75.9	84.1	97.0	124	133	138	155	180	209	229	285	315	
LCE300P	300	29.3	34.6	49.7	67.8	81.4	90.1	104	133	142	148	166	193	224	245	305	338	
LCE330P	330	32.3	38.0	54.7	74.6	89.5	99.1	114	146	156	162	183	212	247	270	336	372	
LCE360P	360	35.2	41.5	59.6	81.4	97.6	108	125	159	171	177	199	232	269	294	366	405	
LCE375P	375	36.7	43.2	62.1	84.8	102	113	130	166	178	184	208	241	280	307	382	422	
LBE400P	400	39.1	46.1	66.3	90.4	108	120	139	177	190	197	221	257	299	327	407	450	
LBE415P	415	40.6	47.8	68.7	93.8	113	125	144	184	197	204	230	267	310	339	422	467	
LBE460P	460	45.0	53.0	76.2	104	125	138	159	204	218	226	255	296	344	376	468	518	
LBE500P	500	48.9	57.6	82.8	113	136	150	173	221	237	246	277	322	374	409	509	563	
LBE510P	510	49.9	58.8	84.5	115	138	153	177	226	242	251	282	328	381	417	519	574	
LBE550P	550	53.8	63.4	91.1	124	149	165	190	243	261	271	304	354	411	450	560	619	
LBE600P	600	58.7	69.1	99.4	136	163	180	208	266	284	295	332	386	449	490	610	676	
LBE650P	650	63.6	74.9	108	147	176	195	225	288	308	320	360	418	486	531	661	732	
LBE700P	700	68.5	80.7	116	158	190	210	242	310	332	344	387	450	523	572	712	788	
LBE750P	750	73.4	86.4	124	170	203	225	260	332	356	369	415	483	561	613	763	845	
LBE800P	800	78.3	92.2	133	181	217	240	277	354	379	394	443	515	598	654	814	901	
LBE830P	830	81.2	95.6	137	188	225	249	287	367	394	408	459	534	621	678	844	935	
LBE890P	890	87.1	103	147	201	241	267	308	394	422	438	493	573	666	727	905	1002	
LBE925P	925	90.5	107	153	209	251	278	320	410	439	455	512	595	692	756	941	1042	
LBE980P	980	95.9	113	162	222	266	294	339	434	465	482	542	631	733	801	997	1104	
LBE1000P	1000	97.8	115	166	226	271	300	346	443	474	492	553	644	748	817	1017	1126	
LBE1020P	1020	100	118	169	231	277	306	353	452	484	502	564	656	763	834	1038	1149	
LBE1070P	1070	105	123	177	242	290	321	371	474	507	526	592	689	800	875	1089	1205	
LBE1100P	1100	108	127	182	249	298	330	381	487	522	541	609	708	823	899	1119	1239	
LBE1150P	1150	113	133	191	260	312	346	398	509	545	566	636	740	860	940	1170	1295	
LBE1200P	1200	117	138	199	271	325	361	416	531	569	590	664	772	897	981	1221	1351	
LBE1250P	1250	122	144	207	283	339	376	433	553	593	615	692	804	935	1022	1272	1408	
LBE1300P	1300	127	150	215	294	353	391	450	576	616	639	719	837	972	1063	1323	1464	
LBE1350P	1350	132	156	224	305	366	406	467	598	640	664	747	869	1010	1103	1373	1520	
LBE1400P	1400	137	161	232	317	380	421	485	620	664	689	775	901	1047	1144	1424	1577	
LBE1450P	1450	142	167	240	328	393	436	502	642	687	713	802	933	1084	1185	1475	1633	
LBE1500P	1500	147	173	248	339	407	451	519	664	711	738	830	965	1122	1226	1526	1689	
LBE1550P	1550	152	179	257	350	420	466	537	686	735	762	858	997	1159	1267	1577	1745	
LBE1600P	1600	157	184	265	362	434	481	554	708	759	787	885	1030	1197	1308	1628	1802	
LBE1660P	1660	162	191	275	375	450	499	575	735	787	817	919	1068	1241	1357	1689	1869	
LBE1690P	1690	165	195	280	382	458	508	585	748	801	831	935	1088	1264	1381	1719	1903	

Single Cell Range

MC / MB Range

Capacities and dimensions - **International System of units**

CONNECTION	Cell type	Capacity	Overall Height*	Width per cell	Length per cell	Approx. Weight per cell	Approx. electrolyte volume between level marks	Electrolyte per cell		Internal resistance	Cell connection bolt per pole
		C _s Ah						Solid	Liquid		
		Ah	mm	mm	mm	Kg	cm ³	kg	L	mOhm	
NORMAL CONNECTION	MC9P	9	270	121	42	1.60	146	0.26	0.80	6.89	M 6
	MC14P	14	270	121	42	1.70	146	0.19	0.60	4.43	M 6
	MC22P	22	270	121	42	1.90	143	0.19	0.60	2.82	M 6
	MC31P	31	270	121	42	2.10	140	0.19	0.60	2.00	M 6
	MC39P	39	270	121	66	3.10	235	0.36	1.10	1.59	M 6
	MC47P	47	270	121	66	3.30	232	0.32	1.00	1.32	M 6
	MC50P	50	270	121	66	3.50	230	0.29	0.90	1.24	M 6
	MC55P	55	270	121	66	3.50	230	0.29	0.90	1.13	M 6
	MC60P	60	357	192	68	6.30	530	0.84	2.60	1.30	M 8
	MC70P	70	357	192	68	6.40	530	0.84	2.60	1.11	M 8
	MC80P	80	357	192	68	6.90	530	0.81	2.50	0.98	M 8
	MC90P	90	357	192	68	6.90	530	0.81	2.50	0.87	M 8
	MC100P	100	357	192	68	7.40	520	0.75	2.30	0.78	M 8
	MC110P	110	357	192	68	7.40	520	0.75	2.30	0.71	M 10
	MC115P	115	357	192	68	7.90	510	0.68	2.10	0.68	M 10
	MC130P	130	357	192	68	7.90	510	0.68	2.10	0.60	M 10
	MC140P	140	357	192	93	10.1	740	1.04	3.20	0.56	M 10
	MC145P	145	357	192	93	10.1	740	1.04	3.20	0.54	M 10
	MC150P	150	357	192	93	10.1	740	1.04	3.20	0.52	M 10
	MC165P	165	357	192	93	10.6	730	1.00	3.10	0.47	M 10
	MC185P	185	357	192	93	11.0	720	0.94	2.90	0.42	M 10
	MC190P	190	413	192	93	11.9	740	1.23	3.80	0.45	M 10
	MC200P	200	413	192	93	12.5	730	1.17	3.60	0.43	M 10
	MC215P	215	413	192	93	12.5	730	1.17	3.60	0.40	M 10
	MC220P	220	413	192	93	13.0	720	1.07	3.30	0.39	M 10
	MC240P	240	413	192	93	13.0	720	1.07	3.30	0.36	M 10
	MC250P	250	413	192	122	16.5	980	1.56	4.80	0.34	2 x M 10
MC260P	260	413	192	122	16.5	980	1.56	4.80	0.33	2 x M 10	
MC285P	285	413	192	122	16.5	980	1.56	4.80	0.30	2 x M 10	
MC310P	310	413	192	122	17.1	970	1.49	4.60	0.28	2 x M 10	
MC335P	335	413	192	122	17.6	970	1.43	4.40	0.26	2 x M 10	
CROSSWISE CONNECTION	MB350P	350	406	195	146	18.8	1080	1.56	4.80	0.25	2 x M 10
	MB370P	370	406	195	159	20.4	1190	1.72	5.30	0.23	2 x M 10
	MB390P	390	406	195	171	22.2	1300	1.91	5.90	0.22	2 x M 10
	MB415P	415	410	195	183	23.7	1400	2.07	6.40	0.21	2 x M 10
	MB440P	440	410	195	183	24.2	1390	1.98	6.10	0.20	2 x M 10
	MB460P	460	410	195	183	24.7	1390	1.91	5.90	0.19	2 x M 10
	MB480P	480	410	195	183	24.7	1390	1.91	5.90	0.18	2 x M 10
	MB505P	505	410	195	213	27.6	1630	2.37	7.30	0.17	3 x M 10
	MB525P	525	410	195	213	27.6	1630	2.37	7.30	0.16	3 x M 10
	MB555P	555	410	195	232	30.3	1790	2.59	8.00	0.15	3 x M 10
	MB575P	575	410	195	232	30.3	1790	2.59	8.00	0.15	3 x M 10
	MB600P	600	410	195	244	32.1	1890	2.75	8.50	0.14	3 x M 10
	MB625P	625	410	195	268	35.4	2100	3.08	9.50	0.14	3 x M 10
	MB645P	645	410	195	268	35.4	2100	3.08	9.50	0.13	3 x M 10
	MB670P	670	410	195	268	35.9	2100	3.01	9.30	0.13	3 x M 10
	MB690P	690	410	195	268	37.0	2080	2.88	8.90	0.12	3 x M 10
	MB720P	720	410	195	268	37.0	2080	2.88	8.90	0.12	3 x M 10
	MB740P	740	410	195	305	40.2	2390	3.43	10.6	0.12	4 x M 10
	MB765P	765	410	195	305	40.2	2390	3.43	10.6	0.11	4 x M 10
	MB790P	790	410	195	317	42.0	2490	3.63	11.2	0.11	4 x M 10
	MB830P	830	410	195	353	47.1	2800	4.11	12.7	0.10	4 x M 10
	MB865P	865	410	195	353	47.1	2800	4.11	12.7	0.10	4 x M 10
	MB890P	890	410	195	353	47.6	2800	4.05	12.5	0.10	4 x M 10
	MB920P	920	410	195	353	49.2	2780	3.82	11.8	0.09	4 x M 10
	MB940P	940	410	195	353	48.7	2780	3.89	12.0	0.09	4 x M 10
	MB965P	965	410	195	373	51.9	2910	4.05	12.5	0.09	6 x M 10
	MB1000P	1000	410	195	402	53.7	3200	4.63	14.3	0.09	5 x M 10
MB1040P	1040	410	195	438	58.7	3510	5.15	15.9	0.08	5 x M 10	
MB1080P	1080	410	195	438	58.7	3510	5.15	15.9	0.08	5 x M 10	
MB1100P	1100	410	195	438	59.3	3500	5.05	15.6	0.08	5 x M 10	
MB1150P	1150	410	195	438	61.4	3470	4.76	14.7	0.07	5 x M 10	
MB1180P	1180	410	195	438	60.9	3480	4.86	15.0	0.07	5 x M 10	
MB1220P	1220	410	195	511	69.0	4110	5.99	18.5	0.07	6 x M 10	
MB1270P	1270	410	195	511	69.0	4110	5.99	18.5	0.07	6 x M 10	
MB1320P	1320	410	195	523	71.0	4200	6.09	18.8	0.07	6 x M 10	
MB1390P	1390	410	195	523	73.7	4170	5.73	17.7	0.06	6 x M 10	
MB1440P	1440	410	195	523	73.7	4170	5.73	17.7	0.06	6 x M 10	

Single Cell Range

MC / MB Range

Capacities and dimensions - **Imperial units**

CONNECTION	Cell type	Capacity	Overall	Width	Length	Approx. Weight per cell	Approx. electrolyte volume between level marks	Electrolyte per cell		Internal resistance *	Cell connection bolt per pole	
		C ₅ Ah	Height*	per cell	per cell			Solid	Liquid			
		Ah	in	in	in			lbs	in ³	lbs		US Gal.
NORMAL CONNECTION	MC9P	9	11	4.8	2	3.53	8.91	0.57	0.21	6.89	M 6	
	MC14P	14	11	4.8	2	3.75	8.91	0.43	0.16	4.43	M 6	
	MC22P	22	11	4.8	2	4.19	8.73	0.43	0.16	2.82	M 6	
	MC31P	31	11	4.8	2	4.63	8.54	0.43	0.16	2.00	M 6	
	MC39P	39	11	4.8	3	6.83	14.3	0.79	0.29	1.59	M 6	
	MC47P	47	11	4.8	3	7.28	14.2	0.71	0.26	1.32	M 6	
	MC50P	50	11	4.8	3	7.72	14.0	0.64	0.24	1.24	M 6	
	MC55P	55	11	4.8	3	7.72	14.0	0.64	0.24	1.13	M 6	
	MC60P	60	14	7.6	3	13.9	32.3	1.86	0.69	1.30	M 8	
	MC70P	70	14	7.6	3	14.1	32.3	1.86	0.69	1.11	M 8	
	MC80P	80	14	7.6	3	15.2	32.3	1.79	0.66	0.98	M 8	
	MC90P	90	14	7.6	3	15.2	32.3	1.79	0.66	0.87	M 8	
	MC100P	100	14	7.6	3	16.3	31.7	1.64	0.61	0.78	M 8	
	MC110P	110	14	7.6	3	16.3	31.7	1.64	0.61	0.71	M 10	
	MC115P	115	14	7.6	3	17.4	31.1	1.50	0.55	0.68	M 10	
	MC130P	130	14	7.6	3	17.4	31.1	1.50	0.55	0.60	M 10	
	MC140P	140	14	7.6	4	22.3	45.2	2.29	0.85	0.56	M 10	
	MC145P	145	14	7.6	4	22.3	45.2	2.29	0.85	0.54	M 10	
	MC150P	150	14	7.6	4	22.3	45.2	2.29	0.85	0.52	M 10	
	MC165P	165	14	7.6	4	23.4	44.5	2.21	0.82	0.47	M 10	
	MC185P	185	14	7.6	4	24.3	43.9	2.07	0.77	0.42	M 10	
	MC190P	190	16	7.6	4	26.2	45.2	2.71	1.00	0.45	M 10	
	MC200P	200	16	7.6	4	27.6	44.5	2.57	0.95	0.43	M 10	
	MC215P	215	16	7.6	4	27.6	44.5	2.57	0.95	0.40	M 10	
	MC220P	220	16	7.6	4	28.7	43.9	2.36	0.87	0.39	M 10	
	MC240P	240	16	7.6	4	28.7	43.9	2.36	0.87	0.36	M 10	
	MC250P	250	16	7.6	5	36.4	59.8	3.43	1.27	0.34	2 x M 10	
	MC260P	260	16	7.6	5	36.4	59.8	3.43	1.27	0.33	2 x M 10	
	MC285P	285	16	7.6	5	36.4	59.8	3.43	1.27	0.30	2 x M 10	
	MC310P	310	16	7.6	5	37.7	59.2	3.29	1.22	0.28	2 x M 10	
	MC335P	335	16	7.6	5	38.8	59.2	3.14	1.16	0.26	2 x M 10	
	CROSSWISE CONNECTION	MB350P	350	16	7.7	6	41.4	65.9	3.43	1.27	0.25	2 x M 10
		MB370P	370	16	7.7	6	45.0	72.6	3.79	1.40	0.23	2 x M 10
MB390P		390	16	7.7	7	48.9	79.3	4.21	1.56	0.22	2 x M 10	
MB415P		415	16	7.7	7	52.2	85.4	4.57	1.69	0.21	2 x M 10	
MB440P		440	16	7.7	7	53.4	84.8	4.36	1.61	0.20	2 x M 10	
MB460P		460	16	7.7	7	54.5	84.8	4.21	1.56	0.19	2 x M 10	
MB480P		480	16	7.7	7	54.5	84.8	4.21	1.56	0.18	2 x M 10	
MB505P		505	16	7.7	8	60.8	99.5	5.21	1.93	0.17	3 x M 10	
MB525P		525	16	7.7	8	60.8	99.5	5.21	1.93	0.16	3 x M 10	
MB555P		555	16	7.7	9	66.8	109	5.71	2.11	0.15	3 x M 10	
MB575P		575	16	7.7	9	66.8	109	5.71	2.11	0.15	3 x M 10	
MB600P		600	16	7.7	10	70.8	115	6.07	2.25	0.14	3 x M 10	
MB625P		625	16	7.7	11	78.0	128	6.79	2.51	0.14	3 x M 10	
MB645P		645	16	7.7	11	78.0	128	6.79	2.51	0.13	3 x M 10	
MB670P		670	16	7.7	11	79.1	128	6.64	2.46	0.13	3 x M 10	
MB690P		690	16	7.7	11	81.6	127	6.36	2.35	0.12	3 x M 10	
MB720P		720	16	7.7	11	81.6	127	6.36	2.35	0.12	3 x M 10	
MB740P		740	16	7.7	12	88.6	146	7.57	2.80	0.12	4 x M 10	
MB765P		765	16	7.7	12	88.6	146	7.57	2.80	0.11	4 x M 10	
MB790P		790	16	7.7	12	92.6	152	8.00	2.96	0.11	4 x M 10	
MB830P		830	16	7.7	14	104	171	9.07	3.35	0.10	4 x M 10	
MB865P		865	16	7.7	14	104	171	9.07	3.35	0.10	4 x M 10	
MB890P		890	16	7.7	14	105	171	8.93	3.30	0.10	4 x M 10	
MB920P		920	16	7.7	14	108	170	8.43	3.12	0.09	4 x M 10	
MB940P		940	16	7.7	14	107	170	8.57	3.17	0.09	4 x M 10	
MB965P		965	16	7.7	15	114	178	8.93	3.30	0.09	6 x M 10	
MB1000P		1000	16	7.7	16	118	195	10.2	3.78	0.09	5 x M 10	
MB1040P		1040	16	7.7	17	129	214	11.4	4.20	0.08	5 x M 10	
MB1080P		1080	16	7.7	17	129	214	11.4	4.20	0.08	5 x M 10	
MB1100P		1100	16	7.7	17	131	214	11.1	4.12	0.08	5 x M 10	
MB1150P		1150	16	7.7	17	135	212	10.5	3.88	0.07	5 x M 10	
MB1180P		1180	16	7.7	17	134	212	10.7	3.96	0.07	5 x M 10	
MB1220P		1220	16	7.7	20	152	251	13.2	4.89	0.07	6 x M 10	
MB1270P	1270	16	7.7	20	152	251	13.2	4.89	0.07	6 x M 10		
MB1320P	1320	16	7.7	21	157	256	13.4	4.97	0.07	6 x M 10		
MB1390P	1390	16	7.7	21	162	254	12.6	4.68	0.06	6 x M 10		
MB1440P	1440	16	7.7	21	162	254	12.6	4.68	0.06	6 x M 10		

* Height including the IP2X terminal cover

Single Cell Range

MC / MB Range

Performance after prolonged float charge of fully charged cells

Available Amperes at + 20°C ± 5°C (+ 68°F ± 9°F)

Final voltage: 1.00 V/cell

Cell type	Capacity C ₅ Ah	Hours							Minutes						Seconds		
		10	8	5	3	2	1.5	1	30	20	15	10	5	1	30	5	1
MC9P	9	0.91	1.13	1.80	2.95	4.28	5.29	7.38	9.52	11.1	12.1	13.9	16.8	24.1	27.6	34.8	38.3
MC14P	14	1.42	1.76	2.80	4.58	6.66	8.23	11.5	14.8	17.3	18.9	21.6	26.1	37.5	43.0	54.1	59.6
MC22P	22	2.23	2.77	4.40	7.19	10.5	13.0	18.2	23.7	27.6	29.8	34.0	40.4	55.7	63.1	75.5	80.2
MC31P	31	3.14	3.91	6.20	10.1	14.8	18.3	25.7	33.3	38.8	41.9	47.9	56.9	78.5	88.9	106	113
MC39P	39	3.95	4.91	7.80	12.8	18.6	23.0	32.3	41.9	48.9	52.8	60.2	71.56	98.8	112	134	142
MC47P	47	4.76	5.92	9.40	15.4	22.4	27.8	39.0	50.5	58.9	63.6	72.6	86.24	119	135	161	171
MC50P	50	5.07	6.30	10.0	16.4	23.8	29.5	41.5	53.8	62.6	67.6	77.2	91.74	127	143	172	182
MC55P	55	5.57	6.93	11.0	18.0	26.2	32.5	45.6	59.1	68.9	74.4	85.0	101	139	158	189	200
MC60P	60	6.09	7.56	12.0	19.7	28.7	35.6	50.4	68.7	79.9	86.9	99.3	118	162	183	223	237
MC70P	70	7.11	8.82	14.0	22.9	33.5	41.6	58.7	80.2	93.2	101	116	138	189	214	260	277
MC80P	80	8.12	10.1	16.0	26.2	38.3	47.5	67.1	91.6	106	116	132	157	216	244	297	317
MC90P	90	9.14	11.3	18.0	29.5	43.1	53.5	75.53	103	120	130	149	177	243	275	334	356
MC100P	100	10.2	12.6	20.0	32.8	47.8	59.4	83.9	115	133	145	165	197	270	306	371	396
MC110P	110	11.2	13.9	22.0	36.0	52.6	65.4	92.3	126	147	159	182	216	297	336	408	435
MC115P	115	11.7	14.5	23.0	37.7	55.0	68.3	96.5	132	153	167	190	226	310	351	427	455
MC130P	130	13.2	16.4	26.0	42.6	62.2	77.2	109	149	173	188	215	256	351	397	482	515
MC140P	140	14.2	17.6	28.0	45.9	67.0	83.2	117	160	186	203	232	275	378	428	520	554
MC145P	145	14.7	18.3	29.0	47.5	69.4	86.2	122	166	193	210	240	285	391	443	538	574
MC150P	150	15.2	18.9	30.0	49.2	71.8	89.1	126	172	200	217	248	295	404	458	557	594
MC165P	165	16.8	20.8	33.0	54.1	78.9	98.0	138	189	220	239	273	325	445	504	612	653
MC185P	185	18.8	23.3	37.0	60.6	88.5	110	155	212	246	268	306	364	499	565	686	732
MC190P	190	19.3	23.9	38.0	62.1	90.8	113	159	217	251	272	310	365	492	550	656	694
MC200P	200	20.4	25.2	40.0	65.4	95.5	119	168	228	264	286	326	384	518	579	691	731
MC215P	215	21.9	27.1	43.0	70.3	103	128	180	245	284	307	351	413	557	622	742	786
MC220P	220	22.4	27.7	44.0	71.9	105	131	185	251	291	314	359	422	570	636	760	804
MC240P	240	24.4	30.2	48.0	78.4	115	143	201	274	317	343	391	461	622	694	829	877
MC250P	250	25.4	31.5	50.0	81.7	119	149	210	285	331	357	408	480	648	723	863	913
MC260P	260	26.5	32.7	52.0	85.0	124	155	218	297	344	372	424	499	674	752	898	950
MC285P	285	29.0	35.9	57.0	93.1	136	169	239	325	377	407	465	547	739	824	984	1041
MC310P	310	31.6	39.0	62.0	101	148	184	260	354	410	443	505	595	803	897	1070	1133
MC335P	335	34.1	42.2	67.0	109	160	199	281	382	443	479	546	643	868	969	1157	1224
MB350P	350	35.6	44.1	70.0	114	167	208	294	399	463	500	571	672	907	1013	1209	1279
MB370P	370	37.7	46.6	74.0	121	177	220	310	422	489	529	603	710	959	1070	1278	1352
MB390P	390	39.7	49.1	78.0	127	186	232	327	445	516	557	636	749	1011	1128	1347	1425
MB415P	415	42.2	52.2	83.0	136	198	247	348	473	549	593	677	797	1075	1201	1433	1516
MB440P	440	44.8	55.4	88.0	144	210	262	369	502	582	629	717	845	1140	1273	1519	1608
MB460P	460	46.8	57.9	92.0	150	220	274	386	525	608	658	750	883	1192	1331	1588	1681
MB480P	480	48.9	60.4	96.0	157	229	285	403	548	635	686	783	922	1244	1389	1657	1754
MB505P	505	51.4	63.6	101	165	241	300	424	576	668	722	823	970	1309	1461	1744	1845
MB525P	525	53.4	66.1	105	172	251	312	440	599	694	750	856	1008	1361	1519	1813	1918
MB555P	555	56.5	69.9	111	181	265	330	466	633	734	793	905	1066	1438	1606	1916	2028
MB575P	575	58.5	72.4	115	188	275	342	482	656	760	822	938	1104	1490	1663	1985	2101
MB600P	600	61.1	75.5	120	196	287	357	503	685	793	858	978	1152	1555	1736	2072	2192
MB625P	625	63.6	78.7	125	204	299	372	524	713	826	893	1019	1200	1620	1808	2158	2284
MB645P	645	65.7	81.2	129	211	308	384	541	736	853	922	1052	1238	1671	1866	2227	2357
MB670P	670	68.2	84.3	134	219	320	398	562	764	886	958	1092	1286	1736	1938	2313	2448
MB690P	690	70.2	86.9	138	225	330	410	579	787	912	986	1125	1325	1788	1996	2382	2521
MB720P	720	73.3	90.6	144	235	344	428	604	821	952	1029	1174	1382	1866	2083	2486	2631
MB740P	740	75.3	93.2	148	242	353	440	621	844	978	1058	1207	1421	1918	2141	2555	2704
MB765P	765	77.9	96.3	153	250	365	455	642	873	1011	1094	1247	1469	1982	2213	2641	2795
MB790P	790	80.4	99.5	158	258	377	470	663	901	1044	1129	1288	1517	2047	2285	2728	2887
MB830P	830	84.5	104	166	271	396	494	696	947	1097	1186	1353	1594	2151	2401	2866	3033
MB865P	865	88.0	109	173	283	413	514	726	987	1144	1236	1410	1661	2242	2502	2987	3161
MB890P	890	90.6	112	178	291	425	529	747	1015	1177	1272	1451	1709	2306	2575	3073	3252
MB920P	920	93.6	116	184	301	439	547	772	1050	1216	1315	1500	1766	2384	2662	3177	3362
MB940P	940	95.7	118	188	307	449	559	789	1072	1243	1344	1533	1805	2436	2719	3246	3435
MB965P	965	98.2	121	193	315	461	574	810	1101	1276	1379	1574	1853	2501	2792	3332	3526
MB1000P	1000	102	126	200	327	478	595	839	1141	1322	1429	1631	1920	2591	2893	3453	3654
MB1040P	1040	106	131	208	340	497	618	873	1187	1375	1487	1696	1997	2695	3009	3591	3800
MB1080P	1080	110	136	216	353	516	642	906	1232	1428	1544	1761	2074	2799	3124	3729	3946
MB1100P	1100	112	138	220	359	525	654	923	1255	1454	1572	1794	2112	2851	3182	3798	4019
MB1150P	1150	117	145	230	376	549	684	965	1312	1520	1644	1875	2208	2980	3327	3971	4202
MB1180P	1180	120	149	236	386	564	702	990	1346	1560	1687	1924	2266	3058	3414	4074	4312
MB1220P	1220	124	154	244	399	583	725	1024	1392	1613	1744	1989	2342	3162	3529	4213	4458
MB1270P	1270	129	160	254	415	607	755	1066	1449	1679	1815	2071	2438	3291	3674	4385	4640
MB1320P	1320	134	166	264	431	631	785	1107	1506	1745	1887	2152	2534	3421	3819	4558	4823
MB1390P	1390	141	175	278	454	664	827	1166	1586	1838	1987	2267	2669	3602	4021	4800	5079
MB1440P	1440	147	181	288	471	688	856	1208	1643	1904	2058	2348	2765	3732	4166	4972	5262

Single Cell Range

MC / MB Range

Performance after prolonged float charge of fully charged cells

Available Amperes at + 20°C ± 5°C (+ 68°F ± 9°F)

Final voltage: 1.05 V/cell

Cell type	Capacity C ₅ Ah	Hours								Minutes						Seconds		
		10	8	5	3	2	1.5	1	30	20	15	10	5	1	30	5	1	
MC9P	9	0.91	1.13	1.78	2.90	4.01	5.06	6.47	8.11	9.65	10.6	11.7	14.0	20.8	23.9	29.4	31.8	
MC14P	14	1.41	1.75	2.77	4.51	6.23	7.87	10.1	12.6	15.0	16.4	18.3	21.8	32.3	37.2	45.8	49.5	
MC22P	22	2.21	2.75	4.36	7.08	9.9	12.5	16.0	20.1	23.8	26.0	28.6	33.4	47.5	53.9	63.9	69.1	
MC31P	31	3.12	3.88	6.14	10.0	13.9	17.6	22.6	28.4	33.5	36.6	40.4	47.1	66.9	76.0	90.0	97.3	
MC39P	39	3.93	4.88	7.72	12.6	17.5	22.1	28.4	35.7	42.1	46.1	50.8	59.3	84.2	95.6	113	122	
MC47P	47	4.73	5.88	9.31	15.1	21.0	26.6	34.2	43.0	50.8	55.5	61.2	71.5	101	115	137	148	
MC50P	50	5.03	6.25	9.90	16.1	22.4	28.3	36.4	45.7	54.0	59.1	65.1	76.0	108	123	145	157	
MC55P	55	5.54	6.88	10.9	17.7	24.6	31.2	40.0	50.3	59.4	65.0	71.6	83.6	119	135	160	173	
MC60P	60	6.05	7.50	11.9	19.4	26.9	34.4	45.3	58.4	68.9	74.9	83.6	97.9	139	157	190	203	
MC70P	70	7.05	8.76	13.9	22.6	31.4	40.1	52.9	68.2	80.4	87.4	97.5	114	162	183	221	237	
MC80P	80	8.06	10.0	15.9	25.8	35.9	45.9	60.5	77.9	91.8	100	111	130	186	210	253	271	
MC90P	90	9.07	11.3	17.9	29.1	40.4	51.6	68.0	87.6	103	112	125	147	209	236	285	304	
MC100P	100	10.1	12.5	19.8	32.3	44.9	57.3	75.6	97.4	115	125	139	163	232	262	316	338	
MC110P	110	11.1	13.8	21.8	35.5	49.4	63.1	83.1	107	126	137	153	179	255	288	348	372	
MC115P	115	11.6	14.4	22.8	37.2	51.6	65.9	86.9	112	132	144	160	188	267	301	364	389	
MC130P	130	13.1	16.3	25.8	42.0	58.3	74.5	98.2	127	149	162	181	212	301	341	411	440	
MC140P	140	14.1	17.5	27.8	45.2	62.8	80.3	106	136	161	175	195	228	325	367	443	473	
MC145P	145	14.6	18.1	28.8	46.8	65.1	83.1	110	141	166	181	202	237	336	380	459	490	
MC150P	150	15.1	18.8	29.8	48.5	67.3	86.0	113	146	172	187	209	245	348	393	475	507	
MC165P	165	16.6	20.6	32.7	53.3	74.1	94.6	125	161	189	206	230	269	383	432	522	558	
MC185P	185	18.6	23.1	36.7	59.8	83.0	106	140	180	212	231	258	302	429	485	585	626	
MC190P	190	19.2	23.8	37.7	61.4	85.3	109	144	184	217	236	258	299	418	470	554	597	
MC200P	200	20.2	25.0	39.6	64.6	89.8	115	151	193	228	248	271	315	440	495	583	628	
MC215P	215	21.7	26.9	42.6	69.5	96.5	123	163	208	245	267	292	338	473	532	627	675	
MC220P	220	22.2	27.5	43.6	71.1	98.8	126	166	213	251	273	299	346	484	544	641	691	
MC240P	240	24.2	30.0	47.6	77.6	108	138	181	232	273	298	326	378	528	594	700	754	
MC250P	250	25.2	31.3	49.6	80.8	112	143	189	242	285	310	339	393	550	619	729	785	
MC260P	260	26.2	32.5	51.5	84.0	117	149	197	251	296	323	353	409	572	643	758	816	
MC285P	285	28.8	35.6	56.5	92.1	128	163	216	276	325	354	387	448	627	705	831	895	
MC310P	310	31.3	38.8	61.4	100	139	178	234	300	353	385	421	488	682	767	904	973	
MC335P	335	33.8	41.9	66.4	108	150	192	253	324	382	416	455	527	737	829	977	1052	
MB350P	350	35.3	43.8	69.4	113	157	201	265	338	399	435	475	551	770	866	1021	1099	
MB370P	370	37.3	46.3	73.3	120	166	212	280	358	422	459	502	582	814	915	1079	1162	
MB390P	390	39.3	48.8	77.3	126	175	224	295	377	444	484	529	614	858	965	1137	1225	
MB415P	415	41.9	51.9	82.3	134	186	238	314	401	473	515	563	653	913	1027	1210	1303	
MB440P	440	44.4	55.0	87.2	142	198	252	333	425	501	546	597	692	968	1089	1283	1382	
MB460P	460	46.4	57.5	91.2	149	207	264	348	445	524	571	624	724	1012	1138	1341	1444	
MB480P	480	48.4	60.0	95.1	155	216	275	363	464	547	596	651	755	1056	1188	1400	1507	
MB505P	505	51.0	63.1	100	163	227	290	382	488	575	627	685	794	1111	1249	1472	1586	
MB525P	525	53.0	65.6	104	170	236	301	397	508	598	652	713	826	1155	1299	1531	1649	
MB555P	555	56.0	69.4	110	179	249	318	420	537	632	689	753	873	1221	1373	1618	1743	
MB575P	575	58.0	71.9	114	186	258	330	435	556	655	714	780	905	1265	1423	1677	1806	
MB600P	600	60.5	75.0	119	194	269	344	454	580	684	745	814	944	1320	1484	1749	1884	
MB625P	625	63.1	78.1	124	202	281	358	473	604	712	776	848	983	1376	1546	1822	1963	
MB645P	645	65.1	80.6	128	208	290	370	488	624	735	801	875	1015	1420	1596	1881	2025	
MB670P	670	67.6	83.8	133	217	301	384	507	648	763	832	909	1054	1475	1658	1954	2104	
MB690P	690	69.6	86.3	137	223	310	396	522	667	786	857	937	1085	1519	1707	2012	2167	
MB720P	720	72.6	90.0	143	233	323	413	544	696	820	894	977	1133	1585	1781	2099	2261	
MB740P	740	74.7	92.5	147	239	332	424	560	715	843	919	1004	1164	1629	1831	2158	2324	
MB765P	765	77.2	95.6	152	247	343	439	578	740	872	950	1038	1203	1684	1893	2231	2402	
MB790P	790	79.7	98.8	157	255	355	453	597	764	900	981	1072	1243	1739	1955	2303	2481	
MB830P	830	83.7	104	165	268	373	476	628	802	946	1031	1127	1306	1827	2054	2420	2606	
MB865P	865	87.3	108	171	280	388	496	654	836	986	1074	1174	1361	1904	2140	2522	2716	
MB890P	890	89.8	111	176	288	400	510	673	860	1014	1105	1208	1400	1959	2202	2595	2795	
MB920P	920	92.8	115	182	297	413	527	696	889	1048	1142	1249	1447	2025	2276	2682	2889	
MB940P	940	94.8	118	186	304	422	539	711	909	1071	1167	1276	1479	2069	2326	2741	2952	
MB965P	965	97.4	121	191	312	433	553	730	933	1100	1198	1310	1518	2124	2388	2814	3030	
MB1000P	1000	101	125	198	323	449	573	756	967	1140	1242	1357	1573	2201	2474	2916	3140	
MB1040P	1040	105	130	206	336	467	596	786	1005	1185	1291	1412	1636	2289	2573	3032	3266	
MB1080P	1080	109	135	214	349	485	619	817	1044	1231	1341	1466	1699	2377	2672	3149	3391	
MB1100P	1100	111	138	218	356	494	631	832	1063	1253	1366	1493	1730	2421	2722	3207	3454	
MB1150P	1150	116	144	228	372	516	659	870	1112	1310	1428	1561	1809	2531	2845	3353	3611	
MB1180P	1180	119	148	234	381	530	677	892	1141	1345	1465	1602	1856	2597	2919	3441	3705	
MB1220P	1220	123	153	242	394	548	699	923	1179	1390	1515	1656	1919	2685	3018	3557	3831	
MB1270P	1270	128	159	252	410	570	728	960	1228	1447	1577	1724	1998	2795	3142	3703	3988	
MB1320P	1320	133	165	262	427	593	757	998	1276	1504	1639	1792	2077	2905	3266	3849	4145	
MB1390P	1390	140	174	275	449	624	797	1051	1344	1584	1726	1887	2187	3059	3439	4053	4365	
MB1440P	1440	145	180	285	465	647	826	1089	1392	1641	1788	1954	2265	3169	3563	4199	4522	

Single Cell Range

MC / MB Range

Performance after prolonged float charge of fully charged cells
Available Amperes at + 20°C ± 5°C (+ 68°F ± 9°F)

Final voltage: 1.10 V/cell

Cell type	Capacity C ₅ Ah	Hours							Minutes					Seconds			
		Ah	10	8	5	3	2	1.5	1	30	20	15	10	5	1	30	5
MC9P	9	0.89	1.11	1.76	2.71	3.73	4.47	5.31	6.63	8.04	8.42	9.60	11.6	16.5	18.5	21.9	23.4
MC14P	14	1.39	1.72	2.73	4.21	5.81	6.95	8.27	10.3	12.5	13.1	14.9	18.1	25.6	28.7	34.1	36.4
MC22P	22	2.18	2.71	4.29	6.61	9.13	10.9	13.0	16.2	19.7	20.6	23.5	28.4	40.3	45.1	53.6	57.3
MC31P	31	3.07	3.81	6.05	9.32	12.9	15.4	18.3	22.8	27.7	29.0	33.1	40.0	56.8	63.6	75.5	80.7
MC39P	39	3.86	4.80	7.61	11.7	16.2	19.4	23.0	28.7	34.9	36.5	41.6	50.3	71.4	80.0	95.0	101
MC47P	47	4.65	5.78	9.17	14.1	19.5	23.3	27.7	34.6	42.0	44.0	50.1	60.7	86.1	96.4	114	122
MC50P	50	4.95	6.15	9.75	15.0	20.7	24.8	29.5	36.8	44.7	46.8	53.3	64.5	91.6	103	122	130
MC55P	55	5.45	6.77	10.7	16.5	22.8	27.3	32.5	40.5	49.2	51.4	58.7	71.0	101	113	134	143
MC60P	60	5.94	7.38	11.7	18.1	25.1	30.4	37.0	46.6	57.0	59.8	68.2	82.8	117	132	157	181
MC70P	70	6.94	8.62	13.7	21.1	29.3	35.5	43.1	54.3	66.5	69.7	79.6	96.6	137	154	183	211
MC80P	80	7.93	9.85	15.6	24.1	33.5	40.5	49.3	62.1	76.0	79.7	91	110	156	176	209	242
MC90P	90	8.92	11.1	17.6	27.1	37.7	45.6	55.5	69.8	85.5	89.7	102	124	176	198	235	272
MC100P	100	9.91	12.3	19.5	30.1	41.9	50.7	61.6	77.6	95.0	100	114	138	195	220	262	302
MC110P	110	10.9	13.5	21.5	33.1	46.1	55.7	67.8	85.4	105	110	125	152	215	242	288	332
MC115P	115	11.4	14.2	22.5	34.6	48.2	58.3	70.9	89.2	109	115	131	159	224	253	301	347
MC130P	130	12.9	16.0	25.4	39.1	54.5	65.9	80.1	101	124	130	148	179	254	286	340	393
MC140P	140	13.9	17.2	27.4	42.1	58.7	70.9	86.3	109	133	139	159	193	273	308	366	423
MC145P	145	14.4	17.8	28.3	43.6	60.8	73.4	89.4	113	138	144	165	200	283	319	379	438
MC150P	150	14.9	18.5	29.3	45.1	62.8	76.0	92.5	116	143	149	171	207	293	330	392	453
MC165P	165	16.3	20.3	32.2	49.7	69.1	83.6	102	128	157	164	188	228	322	363	432	498
MC185P	185	18.3	22.8	36.1	55.7	77.5	93.7	114	144	176	184	210	255	361	407	484	559
MC190P	190	18.8	23.4	37.0	57.4	79.5	96.2	117	146	178	185	211	253	353	393	464	493
MC200P	200	19.8	24.6	38.9	60.4	83.7	101	123	154	187	195	222	266	371	414	489	519
MC215P	215	21.3	26.5	41.8	64.9	90.0	109	132	165	201	209	239	286	399	445	525	558
MC220P	220	21.8	27.1	42.8	66.4	92.1	111	136	169	206	214	244	293	408	456	538	571
MC240P	240	23.8	29.6	46.7	72.5	100	121	148	185	225	234	267	320	446	497	586	623
MC250P	250	24.8	30.8	48.7	75.5	105	127	154	192	234	243	278	333	464	518	611	649
MC260P	260	25.8	32.0	50.6	78.5	109	132	160	200	243	253	289	346	483	538	635	675
MC285P	285	28.2	35.1	55.5	86.1	119	144	176	219	267	277	317	380	529	590	696	740
MC310P	310	30.7	38.2	60.3	93.6	130	157	191	238	290	302	344	413	576	642	757	804
MC335P	335	33.2	41.3	65.2	101	140	170	206	258	314	326	372	446	622	694	818	869
MB350P	350	34.7	43.1	68.1	106	147	177	216	269	328	341	389	466	650	725	855	908
MB370P	370	36.7	45.6	72.0	112	155	187	228	285	346	360	411	493	687	766	904	960
MB390P	390	38.7	48.1	75.9	118	163	197	240	300	365	379	433	519	724	808	953	1012
MB415P	415	41.1	51.1	80.8	125	174	210	256	319	388	404	461	553	770	859	1014	1077
MB440P	440	43.6	54.2	85.6	133	184	223	271	338	412	428	489	586	817	911	1075	1142
MB460P	460	45.6	56.7	89.5	139	193	233	283	354	431	448	511	613	854	952	1124	1194
MB480P	480	47.6	59.1	93.4	145	201	243	296	369	449	467	533	639	891	994	1173	1246
MB505P	505	50.0	62.2	98.3	153	211	256	311	388	473	491	561	673	938	1046	1234	1311
MB525P	525	52.0	64.7	102	159	220	266	323	404	491	511	583	699	975	1087	1283	1362
MB555P	555	55.0	68.4	108	168	232	281	342	427	519	540	617	739	1030	1149	1356	1440
MB575P	575	57.0	70.8	112	174	241	291	354	442	538	559	639	766	1068	1191	1405	1492
MB600P	600	59.5	73.9	117	181	251	304	370	462	562	584	667	799	1114	1242	1466	1557
MB625P	625	61.9	77.0	122	189	262	316	385	481	585	608	694	833	1160	1294	1527	1622
MB645P	645	63.9	79.5	126	195	270	327	397	496	604	628	717	859	1197	1335	1576	1674
MB670P	670	66.4	82.6	130	202	280	339	413	515	627	652	744	892	1244	1387	1637	1739
MB690P	690	68.4	85.0	134	208	289	349	425	531	646	671	767	919	1281	1429	1686	1791
MB720P	720	71.4	88.7	140	217	301	364	444	554	674	701	800	959	1337	1491	1759	1868
MB740P	740	73.3	91.2	144	223	310	375	456	569	693	720	822	986	1374	1532	1808	1920
MB765P	765	75.8	94.3	149	231	320	387	471	589	716	744	850	1019	1420	1584	1869	1985
MB790P	790	78.3	97.3	154	239	331	400	487	608	739	769	878	1052	1467	1636	1930	2050
MB830P	830	82.3	102	162	251	347	420	511	639	777	808	922	1106	1541	1719	2028	2154
MB865P	865	85.7	107	168	261	362	438	533	665	810	842	961	1152	1606	1791	2113	2245
MB890P	890	88.2	110	173	269	373	451	548	685	833	866	989	1186	1652	1843	2174	2310
MB920P	920	91.2	113	179	278	385	466	567	708	861	895	1022	1225	1708	1905	2248	2387
MB940P	940	93.2	116	183	284	394	476	579	723	880	915	1045	1252	1745	1946	2297	2439
MB965P	965	95.6	119	188	291	404	489	594	742	903	939	1072	1285	1792	1998	2358	2504
MB1000P	1000	99.1	123	195	302	419	506	616	769	936	973	1111	1332	1857	2071	2443	2595
MB1040P	1040	103	128	202	314	435	526	641	800	973	1012	1156	1385	1931	2153	2541	2699
MB1080P	1080	107	133	210	326	452	547	665	831	1011	1051	1200	1439	2005	2236	2639	2803
MB1100P	1100	109	136	214	332	461	557	678	846	1029	1070	1222	1465	2042	2278	2688	2855
MB1150P	1150	114	142	224	347	481	582	708	885	1076	1119	1278	1532	2135	2381	2810	2984
MB1180P	1180	117	145	230	356	494	597	727	908	1104	1148	1311	1572	2191	2443	2883	3062
MB1220P	1220	121	150	237	368	511	618	752	939	1142	1187	1356	1625	2265	2526	2981	3166
MB1270P	1270	126	156	247	384	532	643	782	977	1189	1236	1411	1692	2358	2630	3103	3296
MB1320P	1320	131	163	257	399	553	668	813	1015	1235	1284	1467	1758	2451	2733	3225	3425
MB1390P	1390	138	171	271	420	582	704	856	1069	1301	1352	1545	1852	2581	2878	3396	3607
MB1440P	1440	143	177	280	435	603	729	887	1108	1348	1401	1600	1918	2673	2982	3518	3737

Single Cell Range

MC / MB Range

Performance after prolonged float charge of fully charged cells
Available Amperes at + 20°C ± 5°C (+ 68°F ± 9°F)

Final voltage: 1.14 V/cell

Cell type	Capacity C ₂₀ Ah	Hours							Minutes							Seconds		
		Ah	10	8	5	3	2	1.5	1	30	20	15	10	5	1	30	5	1
MC9P	9	0.87	1.08	1.69	2.55	3.24	3.69	4.25	5.23	5.95	6.48	7.46	9.36	13.2	14.8	17.2	17.8	
MC14P	14	1.35	1.68	2.63	3.96	5.05	5.74	6.62	8.14	9.26	10.1	11.6	14.6	20.5	23.0	26.8	27.7	
MC22P	22	2.13	2.64	4.14	6.23	7.90	9.00	10.4	12.8	14.5	15.8	18.2	22.9	32.3	36.2	42.2	43.6	
MC31P	31	3.00	3.72	5.83	8.8	11.2	12.7	14.7	18.0	20.5	22.3	25.7	32.2	45.5	51.0	59.4	61.4	
MC39P	39	3.77	4.68	7.33	11.0	14.1	16.0	18.4	22.7	25.8	28.1	32.3	40.6	57.2	64.2	74.7	77.3	
MC47P	47	4.54	5.64	8.84	13.3	16.9	19.3	22.2	27.3	31.1	33.9	39.0	48.9	68.9	77.3	90.1	93.2	
MC50P	50	4.83	6.00	9.40	14.2	18.0	20.5	23.6	29.1	33.1	36.0	41.5	52.0	73.3	82.3	95.8	99.1	
MC55P	55	5.32	6.60	10.3	15.6	19.8	22.6	26.0	32.0	36.4	39.6	45.6	57.2	80.7	90.5	105	109	
MC60P	60	5.80	7.20	11.3	17.0	21.6	24.6	28.4	34.9	39.7	43.2	49.7	62.4	88.0	98.7	115	119	
MC70P	70	6.77	8.40	13.2	19.8	25.2	28.7	33.1	40.7	46.3	50.4	58.0	72.8	103	115	134	139	
MC80P	80	7.73	9.60	15.0	22.6	28.8	32.8	37.8	46.5	52.9	57.6	66.3	83.2	117	132	153	159	
MC90P	90	8.70	10.8	16.9	25.5	32.4	36.9	42.5	52.3	59.5	64.8	74.6	93.6	132	148	172	178	
MC100P	100	9.67	12.0	18.8	28.3	36.1	41.0	47.3	58.1	66.1	72.0	82.9	104	147	165	192	198	
MC110P	110	10.6	13.2	20.7	31.1	39.7	45.1	52.0	64.0	72.7	79.2	91.2	114	161	181	211	218	
MC115P	115	11.1	13.8	21.6	32.6	41.5	47.2	54.4	66.9	76.0	82.8	95.4	120	169	189	220	228	
MC130P	130	12.6	15.6	24.4	36.8	46.9	53.3	61.4	75.6	86.0	93.6	108	135	191	214	249	258	
MC140P	140	13.5	16.8	26.3	39.6	50.5	57.4	66.2	81.4	92.6	101	116	146	205	230	268	277	
MC145P	145	14.0	17.4	27.3	41.0	52.3	59.5	68.5	84.3	95.9	104	120	151	213	239	278	287	
MC150P	150	14.5	18.0	28.2	42.5	54.1	61.5	70.9	87.2	99.2	108	124	156	220	247	287	297	
MC165P	165	16.0	19.8	31.0	46.7	59.5	67.7	78.0	95.9	109	119	137	172	242	272	316	327	
MC185P	185	17.9	22.2	34.8	52.4	66.7	75.9	87.4	108	122	133	153	192	271	304	355	367	
MC190P	190	18.3	22.7	35.8	54.0	69.5	80.2	94.2	115	131	142	163	204	285	315	365	376	
MC200P	200	19.3	23.9	37.7	56.8	73.2	84.4	99.2	121	138	150	172	214	299	332	384	395	
MC215P	215	20.7	25.7	40.5	61.1	78.7	90.7	107	130	149	161	185	230	322	357	413	425	
MC220P	220	21.2	26.3	41.4	62.5	80.5	92.8	109	133	152	165	189	236	329	365	422	435	
MC240P	240	23.1	28.7	45.2	68.2	87.8	101	119	145	166	180	206	257	359	398	460	474	
MC250P	250	24.1	29.9	47.1	71.0	91.5	106	124	151	173	187	215	268	374	415	480	494	
MC260P	260	25.1	31.1	49.0	73.8	95.2	110	129	157	180	195	223	279	389	431	499	514	
MC285P	285	27.5	34.1	53.7	80.9	104	120	141	172	197	213	245	305	427	473	547	563	
MC310P	310	29.9	37.1	58.4	88.0	113	131	154	187	214	232	266	332	464	514	595	613	
MC335P	335	32.3	40.1	63.1	95.1	123	141	166	202	231	251	288	359	502	556	643	662	
MB350P	350	33.8	41.9	65.9	99.4	128	148	174	211	242	262	300	375	524	581	672	692	
MB370P	370	35.7	44.3	69.7	105	135	156	183	223	256	277	318	396	554	614	710	732	
MB390P	390	37.6	46.7	73.5	111	143	165	193	235	269	292	335	418	584	647	748	771	
MB415P	415	40.0	49.7	78.2	118	152	175	206	250	287	311	356	445	621	689	796	820	
MB440P	440	42.4	52.6	82.9	125	161	186	218	265	304	329	378	471	659	730	844	870	
MB460P	460	44.4	55.0	86.7	131	168	194	228	277	318	344	395	493	689	763	883	909	
MB480P	480	46.3	57.4	90.4	136	176	203	238	290	332	359	412	514	719	797	921	949	
MB505P	505	48.7	60.4	95.1	143	185	213	250	305	349	378	434	541	756	838	969	998	
MB525P	525	50.6	62.8	98.9	149	192	222	260	317	363	393	451	563	786	871	1007	1038	
MB555P	555	53.5	66.4	105	158	203	234	275	335	383	415	476	595	831	921	1065	1097	
MB575P	575	55.4	68.8	108	163	210	243	285	347	397	430	494	616	861	954	1103	1137	
MB600P	600	57.9	71.8	113	170	220	253	297	362	415	449	515	643	898	996	1151	1186	
MB625P	625	60.3	74.8	118	178	229	264	310	377	432	468	537	670	936	1037	1199	1236	
MB645P	645	62.2	77.2	122	183	236	272	320	389	446	483	554	691	966	1070	1238	1275	
MB670P	670	64.6	80.2	126	190	245	283	332	404	463	501	575	718	1003	1112	1286	1325	
MB690P	690	66.5	82.6	130	196	253	291	342	416	477	516	592	739	1033	1145	1324	1364	
MB720P	720	69.4	86.1	136	204	264	304	357	434	497	539	618	772	1078	1195	1381	1423	
MB740P	740	71.4	88.5	139	210	271	312	367	446	511	554	635	793	1108	1228	1420	1463	
MB765P	765	73.8	91.5	144	217	280	323	379	461	528	572	657	820	1145	1269	1468	1512	
MB790P	790	76.2	94.5	149	224	289	333	392	476	546	591	678	847	1183	1311	1516	1562	
MB830P	830	80.0	99.3	156	236	304	350	412	501	573	621	713	889	1243	1377	1593	1641	
MB865P	865	83.4	103	163	246	317	365	429	522	598	647	743	927	1295	1435	1660	1710	
MB890P	890	85.8	106	168	253	326	376	441	537	615	666	764	954	1333	1477	1708	1760	
MB920P	920	88.7	110	173	261	337	388	456	555	636	688	790	986	1378	1527	1765	1819	
MB940P	940	90.6	112	177	267	344	397	466	567	649	703	807	1007	1408	1560	1804	1858	
MB965P	965	93.1	115	182	274	353	407	478	582	667	722	828	1034	1445	1601	1852	1908	
MB1000P	1000	96.4	120	188	284	366	422	496	603	691	748	859	1072	1497	1659	1919	1977	
MB1040P	1040	100	124	196	295	381	439	516	627	718	778	893	1114	1557	1726	1995	2056	
MB1080P	1080	104	129	203	307	395	456	535	651	746	808	927	1157	1617	1792	2072	2135	
MB1100P	1100	106	132	207	312	403	464	545	663	760	823	944	1179	1647	1825	2111	2175	
MB1150P	1150	111	138	217	327	421	485	570	694	794	861	987	1232	1722	1908	2207	2274	
MB1180P	1180	114	141	222	335	432	498	585	712	815	883	1013	1264	1767	1958	2264	2333	
MB1220P	1220	118	146	230	346	447	515	605	736	843	913	1047	1307	1827	2025	2341	2412	
MB1270P	1270	122	152	239	361	465	536	630	766	877	950	1090	1361	1902	2107	2437	2511	
MB1320P	1320	127	158	249	375	483	557	654	796	912	988	1133	1414	1977	2190	2533	2610	
MB1390P	1390	134	166	262	395	509	587	689	838	960	1040	1193	1489	2081	2307	2667	2748	
MB1440P	1440	139	172	271	409	527	608	714	869	995	1078	1236	1543	2156	2390	2763	2847	

Single Cell Range

HC / HB Range

Capacities and dimensions - International System of units

CONNECTION	Cell type	Capacity	Overall Height*	Width per cell	Length per cell	Approx. Weight per cell	Approx. electrolyte volume between level marks	Electrolyte per cell		Internal resistance	Cell connection bolt per pole
		C ₅ Ah	mm	mm	mm	Kg	cm ³	Solid	Liquid		
		Ah	mm	mm	mm	Kg	cm ³	kg	L	mOhm	
NORMAL CONNECTION	HC9P	9	270	121	42	1.80	143	0.23	0.70	3.33	M 6
	HC12P	12	270	121	42	1.90	140	0.23	0.70	2.50	M 6
	HC17P	17	270	121	42	2.10	138	0.19	0.60	1.76	M 6
	HC21P	21	270	121	66	3.00	232	0.36	1.10	1.43	M 6
	HC25P	25	270	121	66	3.20	230	0.36	1.10	1.20	M 6
	HC29P	29	270	121	66	3.30	227	0.32	1.00	1.03	M 6
	HC34P	34	270	121	66	3.50	224	0.29	0.90	0.88	M 6
	HC40P	40	357	192	68	6.50	530	0.87	2.70	0.35	M 8
	HC50P	50	357	192	68	6.90	520	0.84	2.60	0.78	M 8
	HC60P	60	357	192	68	7.30	510	0.81	2.50	0.65	M 10
	HC70P	70	357	192	68	7.70	510	0.78	2.40	0.56	M 10
	HC80P	80	357	192	68	8.10	500	0.71	2.20	0.49	M 10
	HC90P	90	357	192	93	10.3	720	1.10	3.40	0.43	M 10
	HC100P	100	357	192	93	10.7	720	1.07	3.30	0.39	M 10
	HC110P	110	357	192	93	11.1	710	1.04	3.20	0.35	M 10
	HC120P	120	357	192	93	11.4	700	1.00	3.10	0.33	M 10
	HC130P	130	413	192	93	12.6	720	1.26	3.90	0.33	M 10
	HC145P	145	413	192	93	13.0	710	1.20	3.70	0.30	M 10
	HC155P	155	413	192	93	13.4	700	1.17	3.60	0.28	M 10
HC170P	170	413	192	122	16.8	960	1.68	5.20	0.25	2 x M 10	
HC185P	185	413	192	122	17.2	950	1.62	5.00	0.23	2 x M 10	
HC210P	210	413	192	122	18.2	940	1.52	4.70	0.20	2 x M 10	
CROSSWISE CONNECTION	HB230P	230	410	195	159	20.8	1170	1.91	5.90	0.19	2 x M 10
	HB255P	255	410	195	159	21.7	1150	1.78	5.50	0.17	2 x M 10
	HB270P	270	410	195	171	23.4	1260	1.98	6.10	0.16	2 x M 10
	HB280P	280	410	195	183	24.8	1360	2.17	6.70	0.15	2 x M 10
	HB305P	305	410	195	183	25.6	1350	2.07	6.40	0.14	2 x M 10
	HB325P	325	410	195	206	28.1	1530	2.43	7.50	0.13	3 x M 10
	HB345P	345	410	195	232	30.9	1750	2.85	8.80	0.12	3 x M 10
	HB365P	365	410	195	244	31.3	1740	2.79	8.60	0.12	3 x M 10
	HB385P	385	410	195	232	32.2	1730	2.69	8.30	0.11	3 x M 10
	HB400P	400	410	195	244	33.9	1830	2.88	8.90	0.11	3 x M 10
	HB420P	420	410	195	268	37.0	2040	3.27	10.1	0.10	3 x M 10
	HB440P	440	410	195	268	37.4	2040	3.21	9.90	0.10	3 x M 10
	HB460P	460	410	195	268	38.3	2020	3.11	9.60	0.09	3 x M 10
	HB510P	510	410	195	305	42.7	2310	3.56	11.0	0.08	4 x M 10
	HB560P	560	410	195	353	49.2	2720	4.34	13.4	0.08	4 x M 10
	HB600P	600	410	195	353	50.6	2700	4.18	12.9	0.07	4 x M 10
	HB615P	615	410	195	353	51.0	2700	4.15	12.8	0.07	4 x M 10
	HB640P	640	410	195	378	53.2	2890	4.47	13.8	0.07	5 x M 10
	HB655P	655	410	195	390	55.0	2990	4.67	14.4	0.07	5 x M 10
HB670P	670	410	195	402	56.7	3100	4.86	15.0	0.06	5 x M 10	
HB705P	705	410	195	438	61.5	3410	5.41	16.7	0.06	5 x M 10	
HB765P	765	410	195	438	63.7	3370	5.18	16.0	0.06	5 x M 10	
HB800P	800	410	195	463	65.9	3560	5.51	17.0	0.05	6 x M 10	
HB865P	865	410	195	498	72.6	3850	5.90	18.2	0.05	6 x M 10	
HB920P	920	410	195	523	76.4	4050	6.19	19.1	0.05	6 x M 10	

* Height including the IP2X terminal cover

Single Cell Range

HC / HB Range

Capacities and dimensions - Imperial units

CONNECTION	Cell type	Capacity	Overall Height*	Width per cell	Length per cell	Approx. Weight per cell	Approx. electrolyte volume between level marks	Electrolyte per cell		Internal resistance	Cell connection bolt per pole
		C ₅ Ah	in	in	in	lbs	in ³	Solid	Liquid	mOhm	
		Ah	in	in	in	lbs	in ³	lbs	US Gal.	mOhm	
NORMAL CONNECTION	HC9P	9	10.6	4.76	1.65	3.97	8.73	0.50	0.18	3.33	M 6
	HC12P	12	10.6	4.76	1.65	4.19	8.54	0.50	0.18	2.50	M 6
	HC17P	17	10.6	4.76	1.65	4.63	8.42	0.43	0.16	1.76	M 6
	HC21P	21	10.6	4.76	2.60	6.61	14.2	0.79	0.29	1.43	M 6
	HC25P	25	10.6	4.76	2.60	7.05	14.0	0.79	0.29	1.20	M 6
	HC29P	29	10.6	4.76	2.60	7.28	13.9	0.71	0.26	1.03	M 6
	HC34P	34	10.6	4.76	2.60	7.72	13.7	0.64	0.24	0.88	M 6
	HC40P	40	14.1	7.56	2.68	14.3	32.3	1.93	0.71	0.35	M 8
	HC50P	50	14.1	7.56	2.68	15.2	31.7	1.86	0.69	0.78	M 8
	HC60P	60	14.1	7.56	2.68	16.1	31.1	1.79	0.66	0.65	M 10
	HC70P	70	14.1	7.56	2.68	17.0	31.1	1.71	0.63	0.56	M 10
	HC80P	80	14.1	7.56	2.68	17.9	30.5	1.57	0.58	0.49	M 10
	HC90P	90	14.1	7.56	3.66	22.7	43.9	2.43	0.90	0.43	M 10
	HC100P	100	14.1	7.56	3.66	23.6	43.9	2.36	0.87	0.39	M 10
	HC110P	110	14.1	7.56	3.66	24.5	43.3	2.29	0.85	0.35	M 10
	HC120P	120	14.1	7.56	3.66	25.1	42.7	2.21	0.82	0.33	M 10
	HC130P	130	16.3	7.56	3.66	27.8	43.9	2.79	1.03	0.33	M 10
	HC145P	145	16.3	7.56	3.66	28.7	43.3	2.64	0.98	0.30	M 10
	HC155P	155	16.3	7.56	3.66	29.5	42.7	2.57	0.95	0.28	M 10
	HC170P	170	16.3	7.56	4.80	37.0	58.6	3.71	1.37	0.25	2 x M 10
HC185P	185	16.3	7.56	4.80	37.9	58.0	3.57	1.32	0.23	2 x M 10	
HC210P	210	16.3	7.56	4.80	40.1	57.4	3.36	1.24	0.20	2 x M 10	
CROSSWISE CONNECTION	HB230P	230	16.1	7.68	6.26	45.9	71.4	4.21	1.56	0.19	2 x M 10
	HB255P	255	16.1	7.68	6.26	47.8	70.2	3.93	1.45	0.17	2 x M 10
	HB270P	270	16.1	7.68	6.73	51.6	76.9	4.36	1.61	0.16	2 x M 10
	HB280P	280	16.1	7.68	7.20	54.7	83.0	4.79	1.77	0.15	2 x M 10
	HB305P	305	16.1	7.68	7.20	56.4	82.4	4.57	1.69	0.14	2 x M 10
	HB325P	325	16.1	7.68	8.11	61.9	93.4	5.36	1.98	0.13	3 x M 10
	HB345P	345	16.1	7.68	9.1	68.1	107	6.29	2.32	0.12	3 x M 10
	HB365P	365	16.1	7.68	9.61	69.0	106	6.14	2.27	0.12	3 x M 10
	HB385P	385	16.1	7.68	9.13	71.0	106	5.93	2.19	0.11	3 x M 10
	HB400P	400	16.1	7.68	9.6	74.7	112	6.36	2.35	0.11	3 x M 10
	HB420P	420	16.1	7.68	10.6	81.6	124	7.21	2.67	0.10	3 x M 10
	HB440P	440	16.1	7.68	10.6	82.5	124	7.07	2.62	0.10	3 x M 10
	HB460P	460	16.1	7.68	10.6	84.4	123	6.86	2.54	0.09	3 x M 10
	HB510P	510	16.1	7.68	12.0	94.1	141	7.86	2.91	0.08	4 x M 10
	HB560P	560	16.1	7.68	13.9	108	166	9.57	3.54	0.08	4 x M 10
	HB600P	600	16.1	7.68	13.9	112	165	9.21	3.41	0.07	4 x M 10
	HB615P	615	16.1	7.68	13.9	112	165	9.14	3.38	0.07	4 x M 10
	HB640P	640	16.1	7.68	14.9	117	176	9.86	3.65	0.07	5 x M 10
	HB655P	655	16.1	7.68	15.4	121	182	10.3	3.80	0.07	5 x M 10
	HB670P	670	16.1	7.68	15.8	125	189	10.7	3.96	0.06	5 x M 10
HB705P	705	16.1	7.68	17.2	136	208	11.9	4.41	0.06	5 x M 10	
HB765P	765	16.1	7.68	17.2	140	206	11.4	4.23	0.06	5 x M 10	
HB800P	800	16.1	7.68	18.2	145	217	12.1	4.49	0.05	6 x M 10	
HB865P	865	16.1	7.68	19.6	160	235	13.0	4.81	0.05	6 x M 10	
HB920P	920	16.1	7.68	20.6	168	247	13.6	5.05	0.05	6 x M 10	

* Height including the IP2X terminal cover

Single Cell Range

HC / HB Range

Performance after prolonged float charge of fully charged cells
Available Amperes at + 20°C ± 5°C (+ 68°F ± 9°F)

Final voltage: 1.00 V/cell

Cell type	Capacity C ₅ Ah	Hours						Minutes						Seconds		
		8	5	3	2	1.5	1	30	20	15	10	5	1	30	5	1
HC9P	9	1.13	1.80	2.96	4.39	5.79	8.4	15.3	20.4	23.5	28.0	34.7	46.6	52.7	66.9	70.9
HC12P	12	1.50	2.40	3.95	5.86	7.73	11.3	20.4	27.2	31.3	37.3	46.3	62.2	70.2	89.3	94.5
HC17P	17	2.13	3.40	5.59	8.3	10.9	15.9	28.9	38.6	44.4	52.9	65.6	88.1	99.5	126	134
HC21P	21	2.63	4.20	6.90	10.25	13.5	19.7	35.7	47.6	54.8	65.3	81.0	109	123	156	165
HC25P	25	3.13	5.00	8.22	12.2	16.1	23.4	42.5	56.7	65.3	77.7	96.5	130	146	186	197
HC29P	29	3.63	5.80	9.53	14.2	18.7	27.2	49.3	65.8	75.7	90.2	112	150	170	216	228
HC34P	34	4.25	6.80	11.2	16.6	21.9	31.9	57.8	77.1	88.8	106	131	176	199	253	268
HC40P	40	5.02	8.00	13.1	19.5	25.7	37.6	69.0	92.7	108	128	159	206	235	296	325
HC50P	50	6.28	10.0	16.4	24.4	32.1	47.0	86.2	116	135	160	199	258	294	370	407
HC60P	60	7.53	12.0	19.7	29.3	38.6	56.4	103	139	162	193	239	309	353	444	488
HC70P	70	8.79	14.0	23.0	34.1	45.0	65.8	121	162	189	225	279	361	411	519	569
HC80P	80	10.0	16.0	26.3	39.0	51.4	75.2	138	185	216	257	318	412	470	593	651
HC90P	90	11.3	18.0	29.6	43.9	57.9	84.6	155	208	243	289	358	464	529	667	732
HC100P	100	12.6	20.0	32.9	48.8	64.3	94.0	172	232	270	321	398	515	588	741	813
HC110P	110	13.8	22.0	36.1	53.7	70.7	103	190	255	297	353	438	567	647	815	895
HC120P	120	15.1	24.0	39.4	58.5	77.1	113	207	278	324	385	478	618	705	889	976
HC130P	130	16.3	26.0	42.9	63.6	83.7	122	222	299	342	405	491	616	695	845	899
HC145P	145	18.2	29.0	47.9	70.9	93.3	137	248	333	382	451	547	687	776	943	1003
HC155P	155	19.4	31.0	51.2	75.8	99.8	146	265	356	408	482	585	734	829	1008	1072
HC170P	170	21.3	34.0	56.1	83.1	109	160	291	391	448	529	642	806	909	1106	1176
HC185P	185	23.2	37.0	61.1	90.5	119	174	316	425	487	576	698	877	989	1203	1280
HC210P	210	26.3	42.0	69.3	103	135	198	359	483	553	654	793	995	1123	1366	1453
HB230P	230	28.8	46.0	75.9	112	148	217	393	529	606	716	868	1090	1230	1496	1591
HB255P	255	31.9	51.0	84.2	125	164	240	436	586	672	794	963	1208	1364	1658	1764
HB270P	270	33.8	54.0	89.1	132	174	254	462	621	711	840	1019	1279	1444	1756	1868
HB280P	280	35.1	56.0	92.4	137	180	264	479	644	738	871	1057	1327	1498	1821	1937
HB305P	305	38.2	61.0	101	149	196	287	522	701	803	949	1151	1445	1631	1983	2110
HB325P	325	40.7	65.0	107	159	209	306	556	747	856	1011	1227	1540	1738	2114	2248
HB345P	345	43.2	69.0	114	169	222	325	590	793	909	1074	1302	1635	1845	2244	2386
HB365P	365	45.7	73.0	120	179	235	344	624	839	962	1136	1378	1730	1952	2374	2525
HB385P	385	48.2	77.0	127	188	248	363	658	885	1014	1198	1453	1824	2059	2504	2663
HB400P	400	50.1	80.0	132	196	258	377	684	919	1054	1245	1510	1895	2139	2601	2767
HB420P	420	52.6	84.0	139	205	270	396	718	965	1106	1307	1585	1990	2246	2731	2905
HB440P	440	55.1	88.0	145	215	283	415	753	1011	1159	1369	1661	2085	2353	2861	3044
HB460P	460	57.6	92.0	152	225	296	433	787	1057	1212	1432	1736	2180	2460	2992	3182
HB510P	510	63.9	102	168	249	328	481	872	1172	1343	1587	1925	2417	2728	3317	3528
HB560P	560	70.2	112	185	274	361	528	958	1287	1475	1743	2114	2654	2995	3642	3874
HB600P	600	75.2	120	198	293	386	565	1026	1379	1581	1867	2265	2843	3209	3902	4150
HB615P	615	77.0	123	203	301	396	579	1052	1414	1620	1914	2321	2914	3289	4000	4254
HB640P	640	80.2	128	211	313	412	603	1095	1471	1686	1992	2416	3033	3423	4162	4427
HB655P	655	82.1	131	216	320	422	617	1120	1506	1725	2038	2472	3104	3503	4260	4531
HB670P	670	83.9	134	221	328	431	631	1146	1540	1765	2085	2529	3175	3584	4357	4635
HB705P	705	88.3	141	233	345	454	664	1206	1620	1857	2194	2661	3341	3771	4585	4877
HB765P	765	95.8	153	253	374	493	721	1308	1758	2015	2381	2888	3625	4092	4975	5292
HB800P	800	100	160	264	391	515	754	1368	1839	2107	2490	3020	3791	4279	5203	5534
HB865P	865	108	173	286	423	557	815	1479	1988	2279	2692	3265	4099	4627	5625	5983
HB920P	920	115	184	304	450	592	867	1573	2115	2424	2863	3473	4359	4921	5983	6364

Single Cell Range

HC / HB Range

Performance after prolonged float charge of fully charged cells
Available Amperes at + 20°C ± 5°C (+ 68°F ± 9°F)

Final voltage: 1.05 V/cell

Cell type	Capacity C ₅ Ah	Hours						Minutes						Seconds		
	Ah	8	5	3	2	1.5	1	30	20	15	10	5	1	30	5	1
HC9P	9	1.11	1.77	2.91	4.30	5.68	8.21	14.5	17.4	20.2	23.8	28.5	38.5	45.2	55.2	59.6
HC12P	12	1.49	2.36	3.89	5.74	7.58	11.0	19.4	23.3	26.9	31.8	37.9	51.3	60.3	73.7	79.5
HC17P	17	2.10	3.35	5.50	8.13	10.7	15.5	27.4	32.9	38.1	45.0	53.7	72.7	85.4	104	113
HC21P	21	2.60	4.13	6.80	10.0	13.3	19.2	33.9	40.7	47.0	55.6	66.4	89.8	106	129	139
HC25P	25	3.09	4.92	8.09	12.0	15.8	22.8	40.3	48.4	56.0	66.2	79.0	107	126	153	166
HC29P	29	3.59	5.71	9.39	13.9	18.3	26.5	46.8	56.2	65.0	76.8	91.7	124	146	178	192
HC34P	34	4.21	6.69	11.0	16.3	21.5	31.0	54.8	65.9	76.2	90.1	107	145	171	209	225
HC40P	40	4.98	7.88	13.0	19.1	25.1	36.3	65.3	80.0	92.3	109	130	176	200	247	265
HC50P	50	6.22	9.85	16.2	23.9	31.4	45.4	81.6	100	115	137	162	219	250	309	331
HC60P	60	7.47	11.8	19.5	28.7	37.7	54.5	98.0	120	138	164	195	263	300	370	397
HC70P	70	8.71	13.8	22.7	33.5	44.0	63.6	114	140	161	192	227	307	350	432	464
HC80P	80	10.0	15.8	26.0	38.3	50.3	72.7	131	160	185	219	259	351	400	494	530
HC90P	90	11.2	17.7	29.2	43.1	56.6	81.7	147	180	208	246	292	395	450	556	596
HC100P	100	12.4	19.7	32.4	47.9	62.9	90.8	163	200	231	274	324	439	500	617	662
HC110P	110	13.7	21.7	35.7	52.6	69.1	100	180	220	254	301	357	483	550	679	728
HC120P	120	14.9	23.6	38.9	57.4	75.4	109	196	240	277	328	389	527	600	741	795
HC130P	130	16.1	25.6	42.2	62.5	81.9	119	211	256	291	343	399	517	583	704	734
HC145P	145	18.0	28.6	47.1	69.7	91.3	132	235	286	325	382	445	577	651	785	818
HC155P	155	19.2	30.6	50.3	74.5	97.6	141	252	306	347	409	475	616	696	839	875
HC170P	170	21.1	33.5	55.2	81.7	107	155	276	335	381	448	521	676	763	920	959
HC185P	185	23.0	36.5	60.1	88.9	116	169	300	365	415	488	567	736	830	1002	1044
HC210P	210	26.1	41.4	68.2	101	132	191	341	414	471	554	644	835	942	1137	1185
HB230P	230	28.6	45.3	74.7	110	145	210	373	453	516	606	706	914	1032	1245	1298
HB255P	255	31.7	50.3	82.8	123	161	233	414	503	572	672	782	1014	1144	1381	1439
HB270P	270	33.5	53.2	87.6	130	170	246	438	532	605	712	828	1074	1212	1462	1524
HB280P	280	34.8	55.2	90.9	135	176	255	454	552	628	738	859	1113	1257	1516	1580
HB305P	305	37.9	60.1	99	147	192	278	495	601	684	804	936	1213	1369	1651	1721
HB325P	325	40.4	64.1	106	156	205	296	528	641	729	857	997	1292	1459	1760	1834
HB345P	345	42.8	68.0	112	166	217	315	560	680	773	909	1058	1372	1548	1868	1947
HB365P	365	45.3	72.0	118	175	230	333	592	720	818	962	1120	1451	1638	1976	2060
HB385P	385	47.8	75.9	125	185	242	351	625	759	863	1015	1181	1531	1728	2084	2172
HB400P	400	49.7	78.9	130	192	252	365	649	789	897	1054	1227	1590	1795	2166	2257
HB420P	420	52.2	82.8	136	202	264	383	682	828	942	1107	1288	1670	1885	2274	2370
HB440P	440	54.6	86.8	143	211	277	401	714	868	986	1160	1350	1749	1975	2382	2483
HB460P	460	57.1	90.7	149	221	290	419	747	907	1031	1213	1411	1829	2064	2490	2596
HB510P	510	63.3	101	166	245	321	465	828	1006	1143	1344	1564	2028	2289	2761	2878
HB560P	560	69.5	110	182	269	353	511	909	1104	1255	1476	1718	2227	2513	3032	3160
HB600P	600	74.5	118	195	288	378	547	974	1183	1345	1582	1841	2386	2693	3248	3386
HB615P	615	76.4	121	200	295	387	561	998	1213	1379	1621	1887	2445	2760	3330	3470
HB640P	640	79.5	126	208	307	403	584	1039	1262	1435	1687	1963	2545	2872	3465	3611
HB655P	655	81.3	129	213	315	412	597	1063	1291	1468	1727	2009	2604	2940	3546	3696
HB670P	670	83.2	132	217	322	422	611	1087	1321	1502	1766	2055	2664	3007	3627	3781
HB705P	705	87.5	139	229	339	444	643	1144	1390	1580	1858	2163	2803	3164	3817	3978
HB765P	765	95.0	151	248	368	482	698	1242	1508	1715	2017	2347	3042	3433	4142	4317
HB800P	800	99.3	158	260	384	504	729	1298	1577	1793	2109	2454	3181	3590	4331	4514
HB865P	865	107	171	281	416	545	789	1404	1706	1939	2280	2653	3439	3882	4683	4881
HB920P	920	114	181	299	442	579	839	1493	1814	2062	2425	2822	3658	4129	4981	5191

Single Cell Range

HC / HB Range

Performance after prolonged float charge of fully charged cells
Available Amperes at + 20°C ± 5°C (+ 68°F ± 9°F)

Final voltage: 1.10 V/cell

Cell type	Capacity C ₂ Ah	Hours						Minutes						Seconds		
		8	5	3	2	1.5	1	30	20	15	10	5	1	30	5	1
HC9P	9	1.09	1.73	2.84	4.17	5.45	7.68	11.7	13.9	15.8	17.9	22.2	30.6	35.6	45.0	47.4
HC12P	12	1.46	2.30	3.78	5.56	7.26	10.2	15.6	18.6	21.0	23.9	29.6	40.8	47.4	60.0	63.2
HC17P	17	2.06	3.26	5.36	7.87	10.3	14.5	22.1	26.3	29.8	33.9	41.9	57.8	67.2	85.0	89.5
HC21P	21	2.55	4.03	6.62	9.73	12.7	17.9	27.3	32.5	36.8	41.9	51.8	71.4	83.0	105	111
HC25P	25	3.03	4.80	7.88	11.6	15.1	21.3	32.5	38.7	43.8	49.8	61.7	85.0	98.8	125	132
HC29P	29	3.52	5.56	9.14	13.4	17.5	24.8	37.7	44.9	50.8	57.8	71.6	98.6	115	145	153
HC34P	34	4.12	6.52	10.7	15.7	20.6	29.0	44.2	52.6	59.6	67.8	83.9	116	134	170	179
HC40P	40	4.86	7.67	12.6	18.5	24.2	34.5	53.3	64.0	72.1	81.7	101	138	160	196	220
HC50P	50	6.07	9.59	15.8	23.2	30.3	43.1	66.7	80.0	90.2	102	126	173	200	245	274
HC60P	60	7.29	11.5	18.9	27.8	36.4	51.7	80.0	96.0	108	123	151	208	240	294	329
HC70P	70	8.50	13.4	22.1	32.4	42.4	60.3	93.3	112	126	143	176	242	280	343	384
HC80P	80	9.71	15.3	25.2	37.1	48.5	68.9	107	128	144	163	201	277	320	392	439
HC90P	90	10.9	17.3	28.4	41.7	54.6	77.6	120	144	162	184	226	311	360	441	494
HC100P	100	12.1	19.2	31.5	46.3	60.6	86.2	133	160	180	204	252	346	400	490	549
HC110P	110	13.4	21.1	34.7	51.0	66.7	94.8	147	176	198	225	277	381	440	539	604
HC120P	120	14.6	23.0	37.8	55.6	72.7	103	160	192	216	245	302	415	480	588	659
HC130P	130	15.7	25.1	41.1	60.3	78.9	112	171	201	226	255	307	412	469	558	586
HC145P	145	17.5	28.0	45.8	67.3	88.0	125	191	224	252	284	342	460	523	622	654
HC155P	155	18.7	29.9	49.0	71.9	94.0	134	204	240	269	304	366	491	559	665	699
HC170P	170	20.6	32.8	53.7	78.9	103	147	224	263	296	333	401	539	613	730	767
HC185P	185	22.4	35.7	58.4	85.8	112	160	244	286	322	362	437	586	667	794	834
HC210P	210	25.4	40.5	66.3	97.5	127	181	277	325	365	411	496	666	757	901	947
HB230P	230	27.8	44.3	72.7	107	140	198	303	356	400	450	543	729	829	987	1037
HB255P	255	30.8	49.2	80.6	118	155	220	336	394	443	499	602	808	919	1094	1150
HB270P	270	32.6	52.1	85.3	125	164	233	356	417	469	529	637	856	974	1159	1218
HB280P	280	33.9	54.0	88.5	130	170	242	369	433	487	548	661	888	1010	1202	1263
HB305P	305	36.9	58.8	96.4	142	185	263	402	471	530	597	720	967	1100	1309	1375
HB325P	325	39.3	62.7	103	151	197	280	428	502	565	636	767	1030	1172	1395	1466
HB345P	345	41.7	66.5	109	160	209	298	455	533	600	676	814	1094	1244	1481	1556
HB365P	365	44.1	70.4	115	169	221	315	481	564	635	715	862	1157	1316	1567	1646
HB385P	385	46.6	74.2	122	179	234	332	507	595	669	754	909	1220	1388	1652	1736
HB400P	400	48.4	77.1	126	186	243	345	527	618	695	783	944	1268	1442	1717	1804
HB420P	420	50.8	81.0	133	195	255	362	554	649	730	822	991	1331	1514	1803	1894
HB440P	440	53.2	84.8	139	204	267	380	580	680	765	862	1039	1395	1586	1888	1984
HB460P	460	55.6	88.7	145	213	279	397	606	711	800	901	1086	1458	1659	1974	2075
HB510P	510	61.7	98.3	161	237	309	440	672	788	887	999	1204	1617	1839	2189	2300
HB560P	560	67.7	108	177	260	340	483	738	866	974	1097	1322	1775	2019	2403	2525
HB600P	600	72.5	116	190	278	364	518	791	927	1043	1175	1416	1902	2163	2575	2706
HB615P	615	74.4	119	194	285	373	531	811	951	1069	1204	1452	1950	2217	2640	2774
HB640P	640	77.4	123	202	297	388	552	844	989	1113	1253	1511	2029	2308	2747	2886
HB655P	655	79.2	126	207	304	397	565	863	1012	1139	1283	1546	2076	2362	2811	2954
HB670P	670	81.0	129	212	311	407	578	883	1036	1165	1312	1582	2124	2416	2876	3022
HB705P	705	85.2	136	223	327	428	608	929	1090	1226	1381	1664	2235	2542	3026	3179
HB765P	765	92.5	148	242	355	464	660	1008	1182	1330	1498	1806	2425	2758	3283	3450
HB800P	800	96.7	154	253	371	485	690	1054	1237	1391	1567	1888	2536	2885	3434	3608
HB865P	865	105	167	273	401	525	746	1140	1337	1504	1694	2042	2742	3119	3713	3901
HB920P	920	111	177	291	427	558	794	1213	1422	1599	1802	2172	2916	3317	3949	4149

Single Cell Range

HC / HB Range

Performance after prolonged float charge of fully charged cells
Available Amperes at + 20°C ± 5°C (+ 68°F ± 9°F)

Final voltage: 1.14 V/cell

Cell type	Capacity C ₂₀ Ah	Hours						Minutes						Seconds		
		8	5	3	2	1.5	1	30	20	15	10	5	1	30	5	1
HC9P	9	1.05	1.67	2.72	3.81	4.85	6.37	9.32	11.1	12.7	14.6	17.9	24.6	28.7	34.9	41.9
HC12P	12	1.40	2.22	3.62	5.08	6.47	8.50	12.4	14.9	16.9	19.4	23.9	32.8	38.3	46.5	55.8
HC17P	17	1.99	3.15	5.13	7.20	9.16	12.0	17.6	21.0	23.9	27.5	33.9	46.4	54.2	65.9	79.1
HC21P	21	2.45	3.89	6.34	8.89	11.3	14.9	21.7	26.0	29.5	34.0	41.9	57.4	66.9	81.4	97.7
HC25P	25	2.92	4.63	7.55	10.6	13.5	17.7	25.9	30.9	35.1	40.5	49.9	68.3	79.7	96.9	116
HC29P	29	3.39	5.37	8.75	12.3	15.6	20.5	30.0	35.9	40.8	47.0	57.8	79.2	92.4	112	135
HC34P	34	3.97	6.29	10.3	14.4	18.3	24.1	35.2	42.1	47.8	55.1	67.8	92.9	108	132	158
HC40P	40	4.69	7.39	12.1	17.7	22.9	30.5	41.6	49.6	55.6	63.0	77.1	111	128	160	168
HC50P	50	5.87	9.23	15.2	22.1	28.7	38.1	52.0	62.0	69.5	78.7	96.3	138	160	200	210
HC60P	60	7.04	11.1	18.2	26.6	34.4	45.7	62.5	74.4	83.4	94.5	116	166	192	240	252
HC70P	70	8.21	12.9	21.2	31.0	40.1	53.3	72.9	86.8	97.3	110	135	194	224	280	294
HC80P	80	9.39	14.8	24.2	35.4	45.9	60.9	83.3	99.1	111	126	154	221	256	320	336
HC90P	90	10.6	16.6	27.3	39.9	51.6	68.6	93.7	112	125	142	173	249	288	360	378
HC100P	100	11.7	18.5	30.3	44.3	57.3	76.2	104	124	139	157	193	277	320	400	420
HC110P	110	12.9	20.3	33.3	48.7	63.1	83.8	115	136	153	173	212	304	352	440	462
HC120P	120	14.1	22.2	36.4	53.1	68.8	91.4	125	149	167	189	231	332	384	480	504
HC130P	130	15.3	24.1	39.4	55.4	70.3	92.2	135	161	181	205	250	329	377	443	459
HC145P	145	17.1	26.9	43.9	61.8	78.4	103	151	180	202	228	279	366	420	494	512
HC155P	155	18.2	28.7	46.9	66.0	83.8	110	161	192	216	244	299	392	449	528	547
HC170P	170	20.0	31.5	51.5	72.4	91.9	121	177	211	236	268	327	430	493	580	600
HC185P	185	21.8	34.3	56.0	78.8	100	131	193	229	257	291	356	468	536	631	653
HC210P	210	24.7	38.9	63.6	89.5	114	149	219	260	292	331	405	531	608	716	741
HB230P	230	27.1	42.6	69.7	98.0	124	163	239	285	320	362	443	581	666	784	812
HB255P	255	30.0	47.2	77.2	109	138	181	265	316	355	402	491	644	739	869	900
HB270P	270	31.8	50.0	81.8	115	146	191	281	335	375	425	520	682	782	921	953
HB280P	280	32.9	51.9	84.8	119	151	198	291	347	389	441	539	708	811	955	988
HB305P	305	35.9	56.5	92.4	130	165	216	317	378	424	480	588	771	884	1040	1076
HB325P	325	38.2	60.2	98.4	138	176	230	338	403	452	512	626	821	942	1108	1147
HB345P	345	40.6	63.9	104	147	187	245	359	428	480	543	665	872	1000	1176	1218
HB365P	365	42.9	67.6	111	155	197	259	380	452	508	575	703	922	1058	1244	1288
HB385P	385	45.3	71.3	117	164	208	273	401	477	535	606	742	973	1116	1313	1359
HB400P	400	47.1	74.1	121	170	216	284	416	496	556	630	771	1011	1159	1364	1412
HB420P	420	49.4	77.8	127	179	227	298	437	521	584	661	809	1061	1217	1432	1482
HB440P	440	51.8	81.5	133	187	238	312	458	545	612	693	848	1112	1275	1500	1553
HB460P	460	54.1	85.2	139	196	249	326	479	570	640	724	886	1163	1333	1568	1624
HB510P	510	60.0	94	154	217	276	362	531	632	709	803	982	1289	1478	1739	1800
HB560P	560	65.9	104	170	239	303	397	583	694	779	882	1079	1415	1623	1909	1976
HB600P	600	70.6	111	182	256	324	425	625	744	834	945	1156	1516	1739	2046	2118
HB615P	615	72.4	114	186	262	333	436	640	762	855	968	1185	1554	1782	2097	2171
HB640P	640	75.3	119	194	273	346	454	666	793	890	1008	1233	1617	1854	2182	2259
HB655P	655	77.1	121	198	279	354	464	682	812	911	1031	1262	1655	1898	2233	2312
HB670P	670	78.8	124	203	285	362	475	697	830	932	1055	1291	1693	1941	2284	2365
HB705P	705	82.9	131	213	300	381	500	734	874	980	1110	1358	1782	2043	2404	2488
HB765P	765	90.0	142	232	326	414	542	796	948	1064	1205	1474	1933	2217	2608	2700
HB800P	800	94.1	148	242	341	433	567	833	991	1112	1260	1541	2022	2318	2728	2824
HB865P	865	102	160	262	368	468	613	900	1072	1203	1362	1666	2186	2506	2949	3053
HB920P	920	108	170	279	392	497	652	958	1140	1279	1449	1772	2325	2666	3137	3247

Single Cell Range

HC / HB Range for starting application

Performance for fully charged cells by a constant current charge according to IEC 60623
Available Amperes at + 20°C ± 5°C (+ 68°F ± 9°F)

Final voltage: 0.65 V/cell

Cell type	Capacity C ₅ Ah	Minutes		Seconds			
		1.5	1	30	15	5	1
HC9P	9	98.4	106	118	129	143	162
HC12P	12	131	142	158	171	190	216
HC17P	17	186	201	223	243	270	305
HC21P	21	230	248	276	300	333	377
HC25P	25	273	295	328	357	397	449
HC29P	29	317	343	381	414	460	521
HC34P	34	372	402	446	486	539	611
HC40P	40	452	484	532	580	645	718
HC50P	50	565	605	665	724	806	898
HC60P	60	678	726	798	869	967	1078
HC70P	70	791	847	931	1014	1129	1257
HC80P	80	904	968	1064	1159	1290	1437
HC90P	90	1017	1089	1197	1304	1451	1616
HC100P	100	1131	1210	1330	1449	1612	1796
HC110P	110	1244	1331	1463	1594	1773	1976
HC120P	120	1357	1452	1596	1739	1935	2155
HC130P	130	1391	1467	1602	1710	1883	2041
HC145P	145	1552	1636	1786	1908	2101	2277
HC155P	155	1659	1749	1909	2039	2246	2434
HC170P	170	1819	1918	2094	2236	2463	2670
HC185P	185	1980	2088	2279	2434	2680	2905
HC210P	210	2247	2370	2587	2763	3042	3298
HB230P	230	2461	2595	2833	3026	3332	3612
HB255P	255	2729	2878	3141	3355	3694	4004
HB270P	270	2889	3047	3326	3552	3912	4240
HB280P	280	2996	3160	3449	3684	4056	4397
HB305P	305	3264	3442	3757	4012	4419	4789
HB325P	325	3478	3667	4004	4276	4708	5103
HB345P	345	3692	3893	4250	4539	4998	5418
HB365P	365	3906	4119	4497	4802	5288	5732
HB385P	385	4120	4345	4743	5065	5578	6046
HB400P	400	4280	4514	4928	5262	5795	6281
HB420P	420	4494	4739	5174	5525	6085	6595
HB440P	440	4708	4965	5420	5788	6374	6909
HB460P	460	4922	5191	5667	6052	6664	7223
HB510P	510	5457	5755	6283	6709	7389	8009
HB560P	560	5992	6319	6899	7367	8113	8794
HB600P	600	6420	6771	7392	7893	8692	9422
HB615P	615	6581	6940	7576	8091	8910	9657
HB640P	640	6848	7222	7884	8419	9272	10050
HB655P	655	7009	7391	8069	8617	9489	10286
HB670P	670	7169	7561	8254	8814	9707	10521
HB705P	705	7544	7956	8685	9275	10214	11071
HB765P	765	8186	8633	9424	10064	11083	12013
HB800P	800	8560	9028	9855	10524	11590	12562
HB865P	865	9256	9761	10656	11379	12532	13583
HB920P	920	9844	10382	11334	12103	13328	14447

Single Cell Range

HC / HB Range for starting application

Performance for fully charged cells by a constant current charge according to IEC 60623
Available Amperes at + 20°C ± 5°C (+ 68°F ± 9°F)

Final voltage: 0.85 V/cell

Cell type	Capacity C ₅ Ah	Minutes		Seconds			
	Ah	1.5	1	30	15	5	1
HC9P	9	69.5	76.0	84.4	99.2	111	121
HC12P	12	92.6	101	113	132	148	162
HC17P	17	131	143	160	187	210	229
HC21P	21	162	177	197	231	259	283
HC25P	25	193	211	235	276	309	337
HC29P	29	224	245	272	320	358	391
HC34P	34	262	287	319	375	420	458
HC40P	40	319	343	383	441	494	539
HC50P	50	398	429	478	551	617	673
HC60P	60	478	515	574	661	741	808
HC70P	70	558	601	669	771	864	943
HC80P	80	637	687	765	882	988	1078
HC90P	90	717	773	861	992	1111	1212
HC100P	100	796	859	956	1102	1235	1347
HC110P	110	876	944	1052	1212	1358	1482
HC120P	120	956	1030	1148	1322	1482	1616
HC130P	130	966	1028	1135	1253	1383	1507
HC145P	145	1078	1146	1266	1398	1543	1681
HC155P	155	1152	1225	1353	1494	1649	1797
HC170P	170	1263	1344	1484	1639	1809	1971
HC185P	185	1375	1463	1615	1783	1968	2145
HC210P	210	1561	1660	1833	2024	2234	2435
HB230P	230	1709	1818	2007	2217	2447	2667
HB255P	255	1895	2016	2226	2458	2713	2957
HB270P	270	2007	2135	2357	2603	2873	3131
HB280P	280	2081	2214	2444	2699	2979	3247
HB305P	305	2267	2411	2662	2940	3245	3537
HB325P	325	2415	2570	2837	3133	3458	3768
HB345P	345	2564	2728	3011	3326	3671	4000
HB365P	365	2713	2886	3186	3518	3883	4232
HB385P	385	2861	3044	3360	3711	4096	4464
HB400P	400	2973	3162	3491	3856	4256	4638
HB420P	420	3121	3321	3666	4049	4468	4870
HB440P	440	3270	3479	3840	4241	4681	5102
HB460P	460	3419	3637	4015	4434	4894	5334
HB510P	510	3790	4032	4451	4916	5426	5914
HB560P	560	4162	4427	4888	5398	5958	6493
HB600P	600	4459	4744	5237	5784	6384	6957
HB615P	615	4571	4862	5368	5928	6543	7131
HB640P	640	4756	5060	5586	6169	6809	7421
HB655P	655	4868	5179	5717	6314	6969	7595
HB670P	670	4979	5297	5848	6458	7128	7769
HB705P	705	5239	5574	6153	6796	7501	8175
HB765P	765	5685	6048	6677	7374	8139	8870
HB800P	800	5945	6325	6982	7712	8511	9276
HB865P	865	6428	6839	7550	8338	9203	10030
HB920P	920	6837	7274	8030	8868	9788	10668

A responsible corporate citizen

Alcad is committed to protecting and preserving the environment. We are engaged in a sustained effort to use resources responsibly and to act in a way that clearly demonstrates our great respect for the planet.

Alcad LTD has set up a network of Bring Back Points (BBPS) which receive end-of-life nickel based batteries from end users free of charge. These batteries are then shipped by these BBPs to our recycling facility in Sweden or to fully permitted recycling companies, in compliance with the laws governing trans-boundary waste shipments.

The recycling efficiency of these recyclers exceeds 75% of the nickel based battery weight (a level which exceeds the mandated recycling efficiency of 65% applicable to lead-acid batteries), and recycled materials are reused as secondary raw material for industry.

This network of Bring Back Points comprises over 30 entities, and provides services in all of our major markets in Europe, North America, Asia and Africa. The list of BBPs and their contact details are available on the Alcad website.



THE ALCAD
PLANT IN
OSKARSHAMN,
SWEDEN HAS ITS OWN
IN-HOUSE RECYCLING
FACILITY

Alcad Sales Offices

Middle East

Telephone: +357 25 871 816
middleeast@alcad.com

Asia

Telephone: +65 6 7484 486
asia@alcad.com

North America

Telephone: +1 203 985 2500
northamerica@alcad.com

Africa

Telephone: +33 1 58 63 16 93
africa@alcad.com

South America

Telephone: +46 491 68 100
southamerica@alcad.com

Europe

Telephone: +46 491 68 100
alcad.sweden@alcad.com

Alcad Limited Headquarters

Sweden

Telephone: +46 491 68 100
alcad.sweden@alcad.com

Reliability inside

ALCAD

www.alcad.com