

Rack Range  
Ni-Cd **batteries**



Reliability inside

**ALCAD**

# A wide range of rugged and modular battery racks meeting stringent specifications



## Alcad offers a full and modular range of battery racks

- Standard racks
- Seismic racks (EQ)
- Compact racks

Battery racks are used for arranging cells in a safe and organized setup to achieve the best performance out of the battery system. When selecting the best racking solution for your system you need to consider room dimensions, maintenance requirements and specific conditions.

Our modular racking system can be used for all our cells, from standard to maintenance-free nickel technology batteries. You can build the ideal rack and battery system with Alcad BaSics software. Our experts can also give you guidance on the appropriate rack and battery sizing for end-user requirement.

All racks are built up in the same way, with supports (gables) and stringers (which hold the cells) in a large variation of dimensions to fit many needs. All dimensions are sizable in length, width and height depending on cell dimensions and the number of cells in a battery system. These define how many rows there will be in the rack and the length of each row.

## Alcad racks are carefully designed to meet stringent specifications

- All racks are fully insulated:
  - The dielectric strength is verified in accordance with standard IEC 62485-2 (EN 50272-2).
- Coatings are resistant against the chemicals used in the batteries:
  - Chemical resistance in accordance with standard EN ISO 2812, 05-2007.
  - Adhesion of the epoxy coating in accordance with standard EN ISO 2409, 06-2013.
  - Polyethylene (PE) coating in accordance with standard EN ISO 16276, 08-2007.
- Operating temperature: -50°C to +70°C.
- Racks are compliant to RoHS European Directives.
- Design life of more than 25 years at room temperature (20 - 25 °C)





# Standard racks: robust & easy-to-use



## Standard battery racks

Alcad standard racks are compatible with all our stationary battery cells. These easy-to-use racks are robust, have a modular design, and are chemical-resistant. Their light, small compact structure makes them easy to store, transport and install.

Our nickel technology racks offer a complete range with options of 1 to 2 tiers and from 1 to 4 rows in steps. Furthermore, the length of the racks can be adapted between 600 to 9000 mm.

## A rugged rack range

Alcad racks are particularly rugged: our stringers are made of a folded steel plate and coated with black polyethylene (PE) material giving electrolyte protection. Furthermore, the PE's insulating properties ensure protection against electric shock.

Its modular design meets any type of installation requirements, making it the most functional equipment on the market with a limited number of components included.

Our stringers are available in many sizes with length from 600 to 1500 mm and in steps of 150 mm. There are two types of stringers, made of cold shaped steel sections depending on the rack usage.

## Standard & crosswise installation configuration

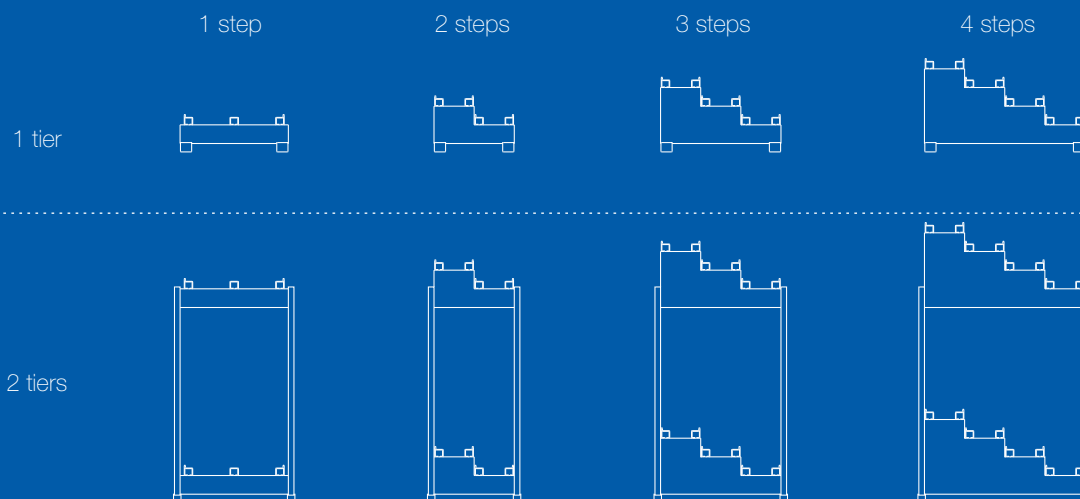

# Standard battery racks

## Optional accessories

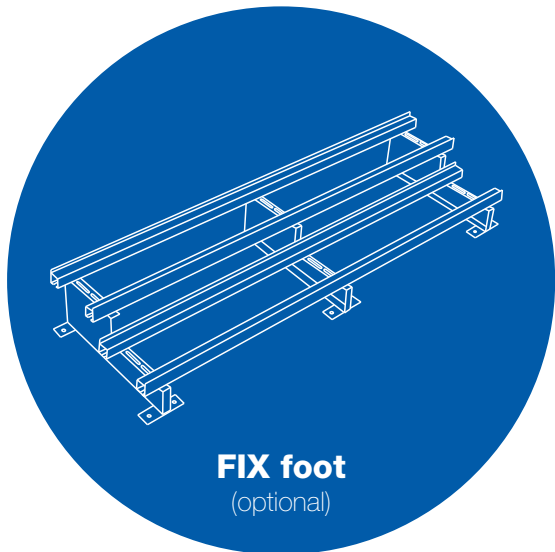

Alcad FIX foot is ideal in applications (like Oil & Gas, Utilities) where there is a need to fix the rack to the floor, but without seismic requirements.

The FIX foot is available for standard and compact battery racks and will replace the original foot that is supplied with the rack.



In some applications extra ground clearance is required, usually to give operators better access to the batteries. Our ground clearance solution can be added to the standard rack when there is a requirement for more space between ground and the stringers of the first tier: Alcad ground clearance is 300 mm.



### Cladded Racks (optional)

Alcad cladded rack solution is designed for battery rooms where access is non-restricted or areas where higher personal protection against electricity is required.

The cladded rack system is based on our standard rack model with additional modular cladded panels of thermoplastic compound. This is a more flexible solution compared to a cabinet, since it is based on the configuration of a standard rack. Specifications of the cladding:

- Shock resistance according to IK 10 EN 50102
- Dielectric strength 6 kV according to EN 60950 and EN 50272-2
- Fire protection UL 94V0/ISO 1210
- Ageing (extreme conditions) according to XP C 20-540
- Chemically resistant against potassium hydroxide (KOH)
- Color: RAL 7035, Light Grey



# Seismic battery racks



Seismic racks are designed for regions experiencing earthquakes, seismic movements, or for specific applications such as ships, offshore oil & gas and wind platforms. When the rack is located in a seismic area, it requires the correct anchoring, always fixed to the floor. Our seismic solutions constrain the cells and restrict movements in case of an event.

Alcad seismic rack range is certified for acceleration forces from 0,1g to 1,0g (1g is equivalent to 9 on the Richter scale) and IBC type 1 to IBC type 4.

These stronger racks are available in 1 or 2 tiers and 1 or 2 rows with length between 600 and 6000 mm.

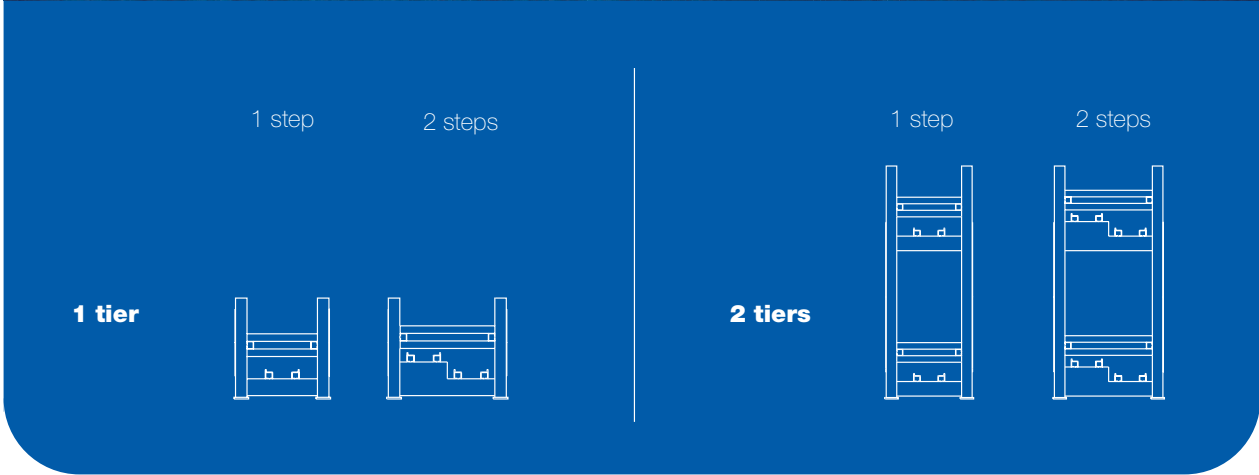

# Compact battery racks

In applications where space is expensive or restricted (Oil & Gas, Offshore platforms), the compact rack increases the installed capacity in the same space, saving money.

Alcad compact racks have been designed for Vantex maintenance free cells. When choosing our compact rack, you save up to 50% of footprint compared to standard rack by reducing the height between the tiers.

There are many different configurations to answer specific requirements, depending on cell capacity and numbers. With our compact racks we offer various lengths between 600 to 9000 mm.

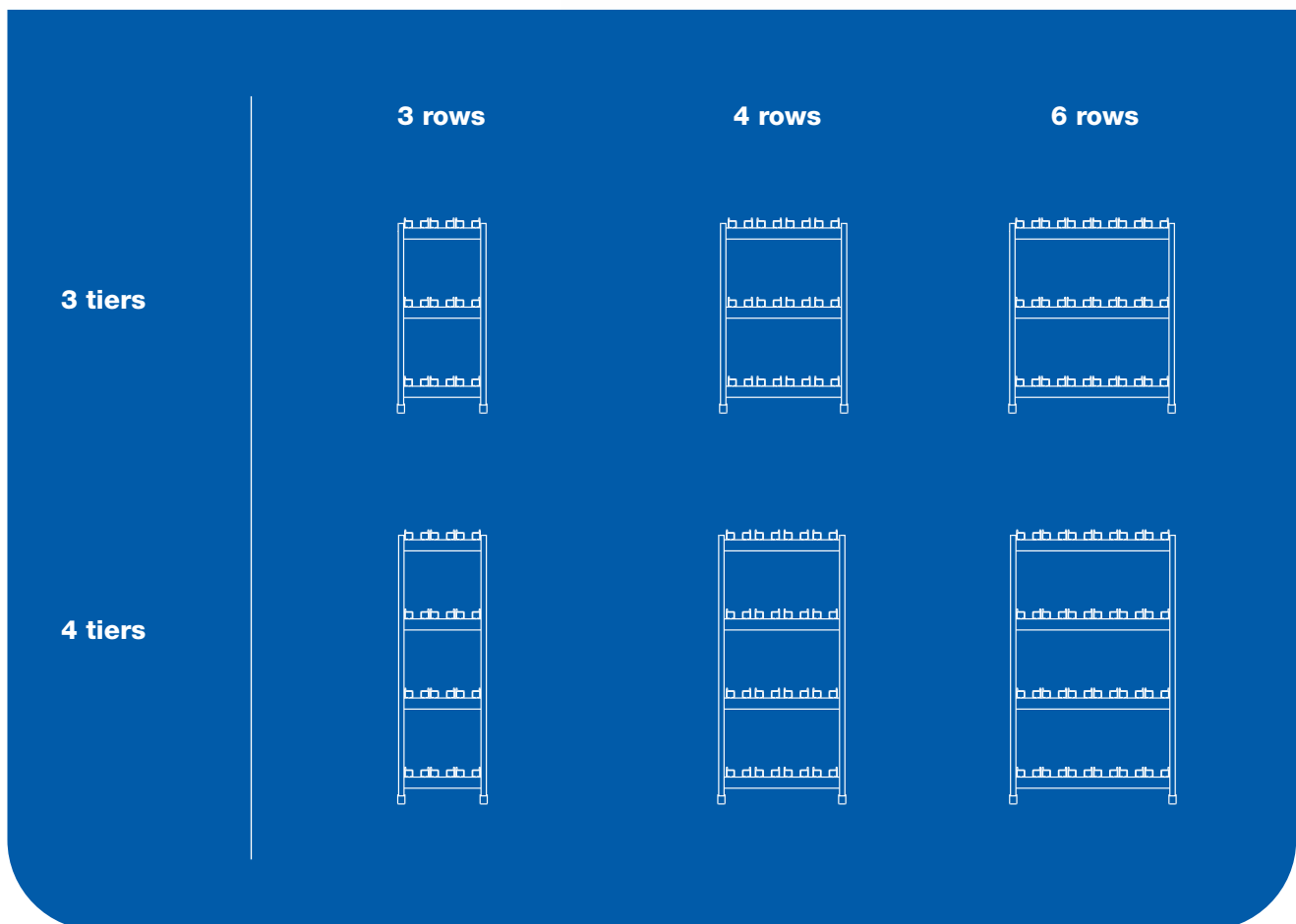

# Additional accessories to meet all your needs

## Drip Trays

Drip Trays are used with vented type batteries according to IEC 62485-2, when the floor is not fulfilling impermeability and chemical resistance to the electrolyte.

Our Drip Trays are manufactured in Polyethylene (PE) and are available in various dimensions to fit your battery installation perfectly.



---

## Accessories

Alcad offers a wide range of accessories to use when installing a battery system and rack. Some of the parts can improve your battery installation.

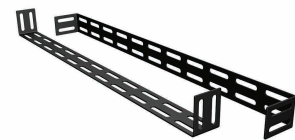
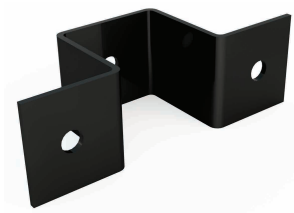

---

## Customization

Alcad offers a wide range of racks. Nevertheless, for specific requirements, our experts can provide the right solution to meet your needs. Besides standard, seismic and compact rack systems, we supply specific constructions for applications such as container, offshore, power stations or utility sites.

We support you to create customized solutions, like cabinets and racks with non-standard dimensions to fulfill specific standards or specifications. We provide solutions fulfilling specific requirements such as IP65, ATEX, change colors (RAL), connection boxes, wall mount etc. For every customized construction we guarantee robustness with a static calculation.

Please contact Alcad if you have any specific requirements.

---

## BaSiCs software sizing service

The rack design can be easily created after sizing the battery for a complete solution.

Our battery sizing calculation software can be downloaded on our website here:

<https://www.alcad.com/services/battery-sizing>

# A responsible corporate citizen

Alcad is committed to protecting and preserving the environment. We are engaged in a sustained effort to use resources responsibly and to act in a way that clearly demonstrates our great respect for the planet.

Alcad LTD has set up a network of Bring Back Points (BBPS) which receive end-of-life nickel based batteries from end users free of charge. These batteries are then shipped by these BBPs to our recycling facility in Sweden or to fully permitted recycling companies, in compliance with the laws governing trans-boundary waste shipments.

The recycling efficiency of these recyclers exceeds 75% of the nickel based battery weight (a level which exceeds the mandated recycling efficiency of 65% applicable to lead-acid batteries), and recycled materials are reused as secondary raw material for industry.

This network of Bring Back Points comprises over 30 entities, and provides services in all of our major markets in Europe, North America, Asia and Africa. The list of BBPs and their contact details are available on the Alcad website.



THE ALCAD  
PLANT IN  
OSKARSHAMN,  
SWEDEN HAS ITS OWN  
IN-HOUSE RECYCLING  
FACILITY

## Alcad Sales Offices

### Middle East

Telephone: +357 25 871 816  
middleeast@alcad.com

### Asia

Telephone: +65 6 7484 486  
asia@alcad.com

### North America

Telephone: +1 203 985 2500  
northamerica@alcad.com

### Africa

Telephone: +33 1 58 63 16 93  
africa@alcad.com

### South America

Telephone: +46 491 68 100  
southamerica@alcad.com

### Europe

Telephone: +46 491 68 100  
alcad.sweden@alcad.com

## Alcad Limited Headquarters

### Sweden

Telephone: +46 491 68 100  
alcad.sweden@alcad.com

## Reliability inside

# ALCAD

[www.alcad.com](http://www.alcad.com)